

ASSEMBLY INSTRUCTION FOR MODEL

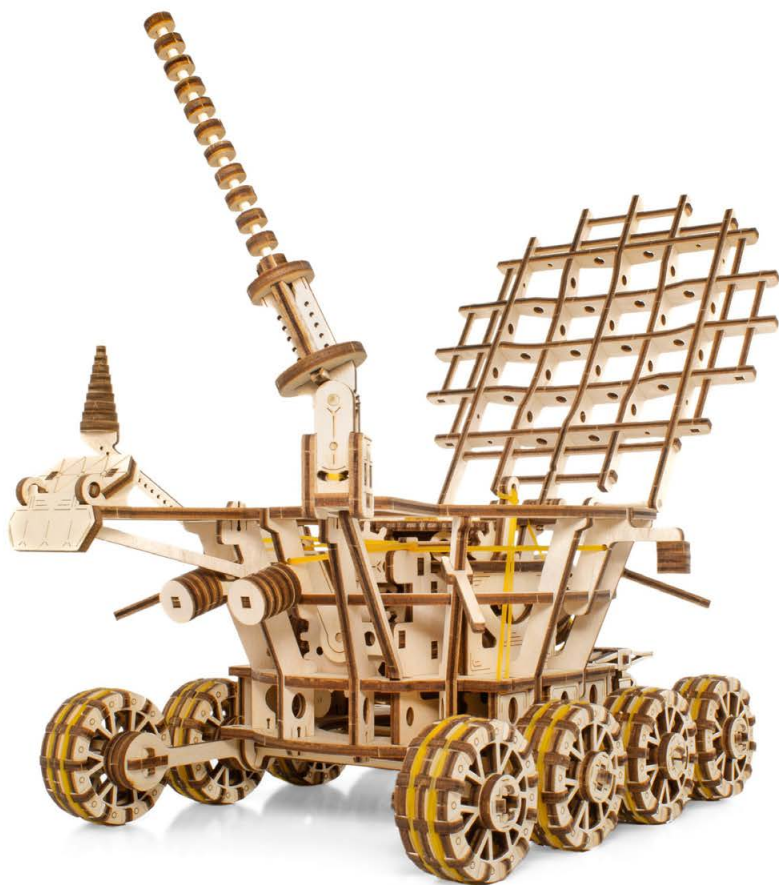

LUNOKHOD

EN The ledge is for the squeezing the small details out of the board
 PL Występ w linijce przeznaczony jest do wyciskania małych detali z arkusza sklejk
 FR La proéminence est conçue pour aider à presser et enlever les petits détails de la feuille
 ES La repisa es para apretar los pequeños detalles fuera del tablero
 DE Der Vorsprung dient dazu, kleine Teile aus den Platten zu drücken
 RU Выступ предназначен для выдавливания из листа мелких деталей
 IT Le proiezioni riportate sui fogli di istruzione sono utili anche nella fase di smontaggio per estrarre i pezzi
 CZ Použitje k vytlačení malých částí z desky
 CN 輔助測量尺可幫助取出或緊壓細小零件時使用

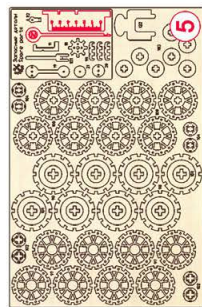

EN Use for the change the length
 PL Stosować do wyznaczenia długości
 FR Appliquer pour définir la longueur
 ES Utilizar para determinar la longitud
 DE Zur Änderung der Länge verwenden
 RU Использовать для определения длины
 IT Usare per determinare la lunghezza
 CZ Použitje pro zméření délky
 CN 用它來測量長度

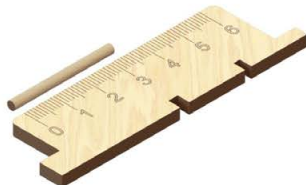

EN Rubber bands
 PL Gumki recepturki
 FR Des élastiques
 ES Gomas elásticas
 DE Gummibänder
 RU Резинки
 IT Elastici
 CZ Gumičky
 CN 枚橡皮筋



EN Cut it with a razor blade
 PL Odetniij nożem do kopert
 FR Couper avec un cutter
 ES Cortar con un bisturí
 DE Mit Rasierklinge durchschneiden
 RU Обрезать канцелярским ножом
 IT Tagliare con un coltello da cancelleria
 CZ Vyřizněte fezákem
 CN 用刀片切斷



EN Remove the burrs with sandpaper
 PL Usunąć zadziory papierem ściernym
 FR Retirer les bavures avec du papier à polir
 ES Quitar las rebabas con el papel esmeril
 DE Grate mit Schleifpapier entfernen
 RU Удалить заусенцы наждачной бумагой
 IT Sbavare con carta vetrata
 CZ Vyhlaďte smirkových papírem
 CN 用砂紙去除毛刺。



EN Details should rotate freely
 PL Swobodne obracanie
 FR Libre rotation
 ES Rotación libre
 DE Auf freie Rotation achten
 RU Свободное вращение
 IT Rotazione libera
 CZ Části by se měly volně otáčet
 CN 流暢地旋轉



EN Wax it with a candle
 PL Posmaruj za pomocą świecy parafinowej
 FR Graisser avec une bougie de paraffine
 ES Engrasar con ayuda de una vela de parafina
 DE Mit einer Kerze wachsen
 RU Смазать парафиновой свечой
 IT Lubrificare con candela di paraffina
 CZ Navoskujte svíčkou
 CN 用干蠟燭上蠟潤滑



EN Pay attention
 PL Uwaznie
 FR Prêter attention
 ES Prestar atención
 DE Achtung
 RU Уделить внимание
 IT Prestare attenzione
 CZ Pozor
 CN 請注意

EN The manufacturer reserves the right to make changes in the design of the product, not worsening its technical characteristics. Information about the changes made may not be present in this manual.

PL Producent zastrzega sobie prawo do zmiany konstrukcji wyrobu bez pogorszenia jego właściwości technicznych. Niniejsza instrukcja może nie zawierać informacji o zmianach.

FR Le producteur se réserve le droit d'apporter des modifications dans la construction du produit à condition si elles ne portent atteinte à ses caractéristiques techniques. Les renseignements sur les modifications apportées peuvent ne pas être dans la présente notice.

ES El fabricante se reserva el derecho de introducir modificaciones en la construcción del producto, que no empeoran sus características técnicas. Datos sobre modificaciones Introducidas pueden no aparecer en esta instrucción.

DE Der Hersteller behält sich das Recht auf Designänderungen, die die technischen Merkmale und Funktionen nicht negativ beeinflussen, vor.

RU Производителю оставляет за собой право вносить изменения в конструкцию изделия, не ухудшающие его технические характеристики. Сведения о внесенных изменениях могут отсутствовать в настоящей инструкции.

IT Il produttore si riserva il diritto di apportare modifiche al design del prodotto, non peggiorando le sue caratteristiche tecniche. Informazioni sulle modifiche apportate potrebbero non essere presenti in questo manuale.

CZ Výrobce si vyhrazuje právo na takové změny v designu produktu, které nebudou mít za následek zhoršení technických vlastností. Informace o změnách nemusí být v návodu uvedeny.

1 CN 制造商保留對產品設計更改的權利，一切改良旨在增強產品的技術性能。改良處若未出現在手冊中，敬請諒解

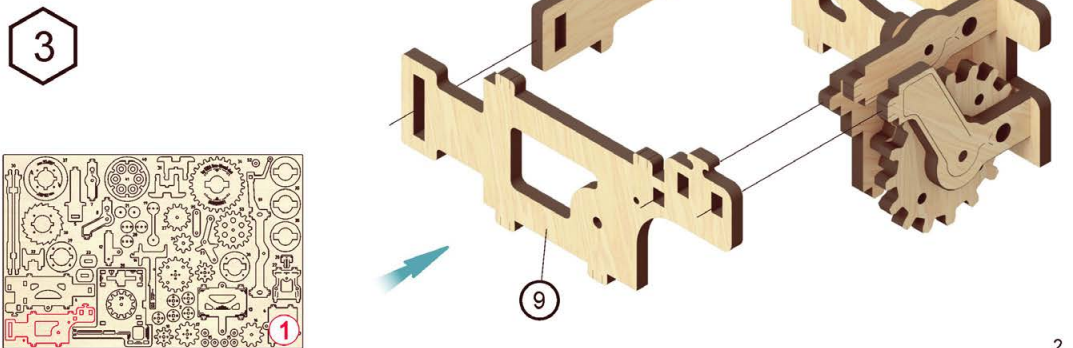
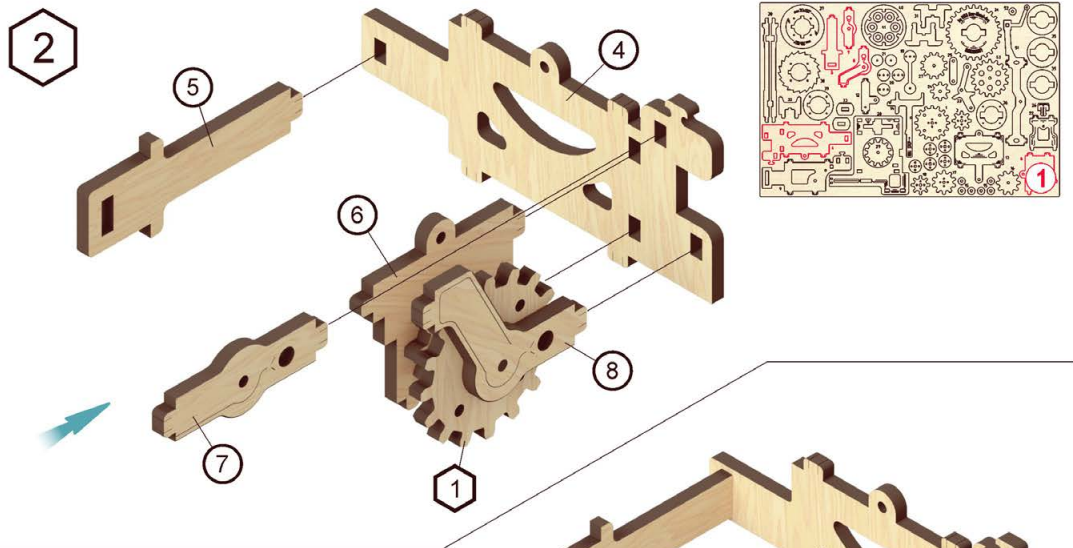
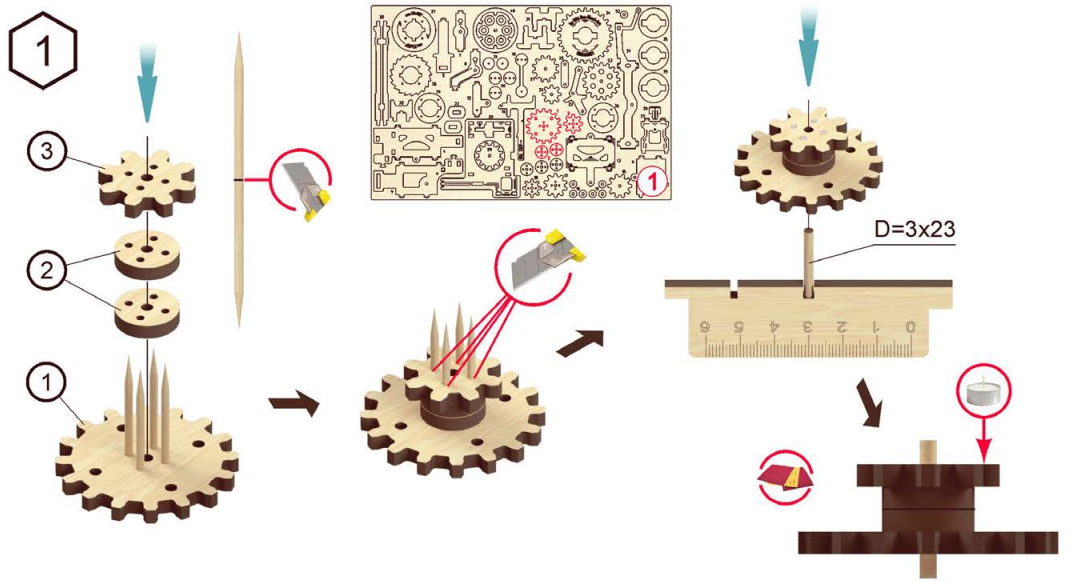

4

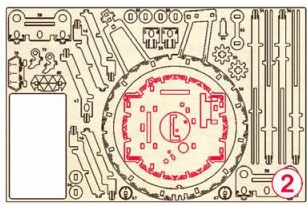
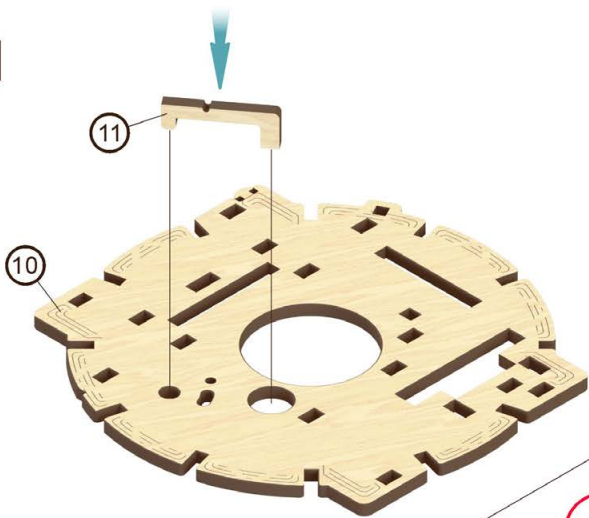

5

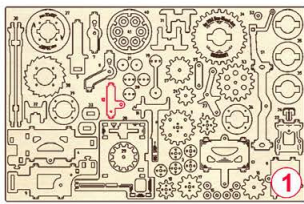
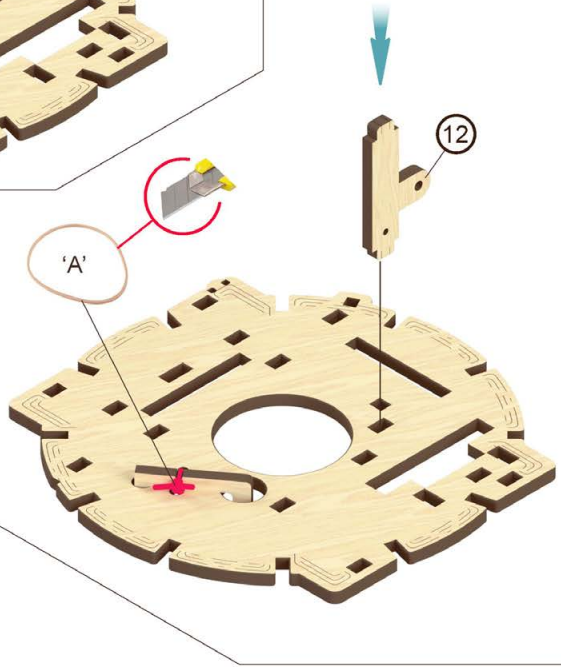

6

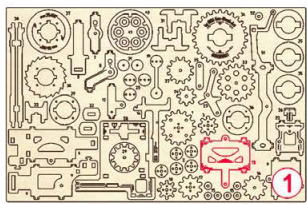
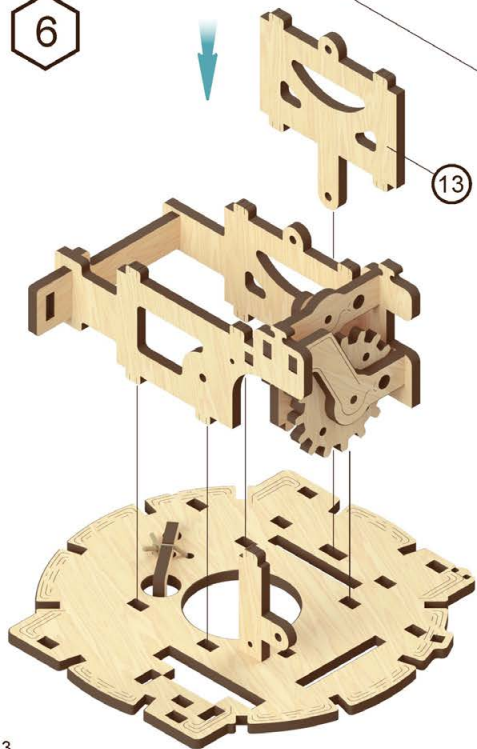

7

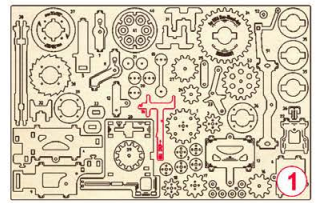
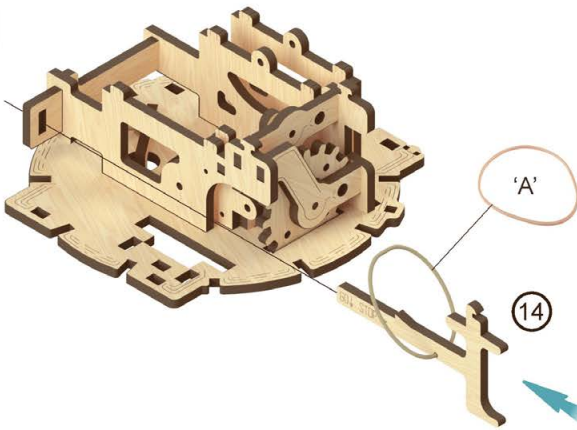

8

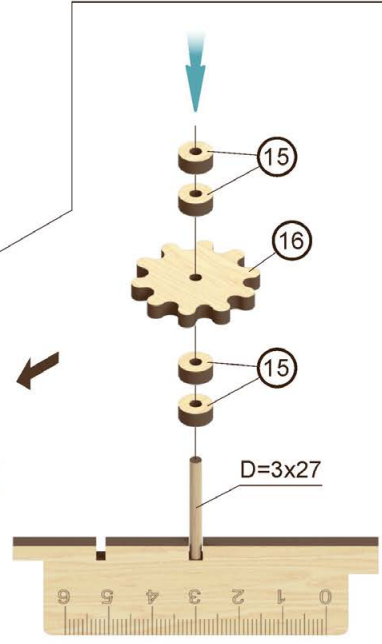
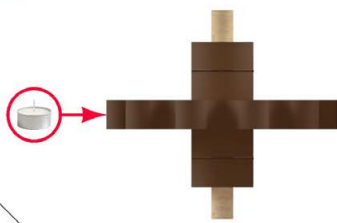

9

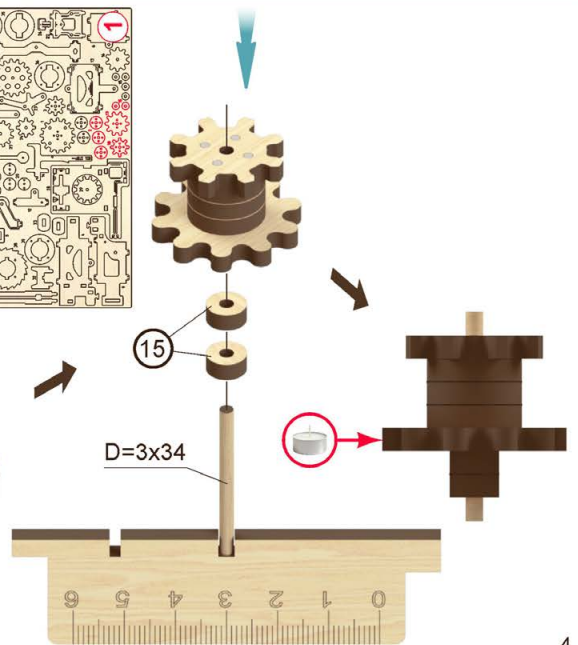
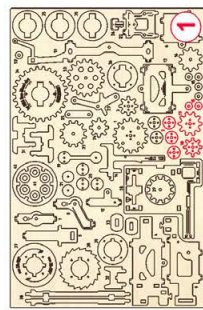
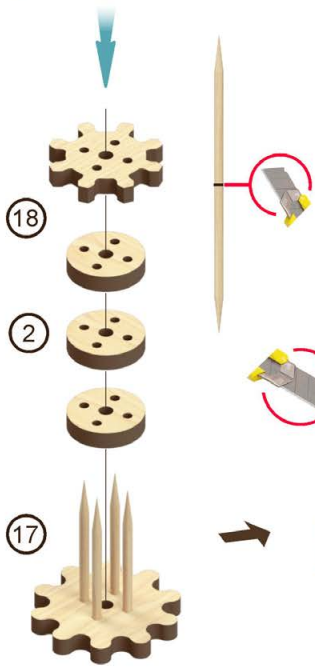

12

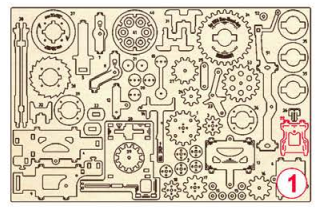
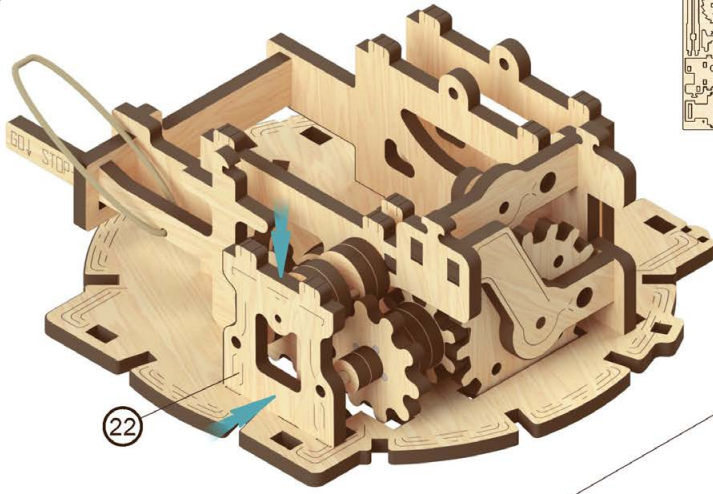

13

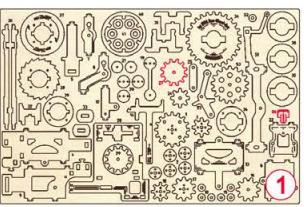
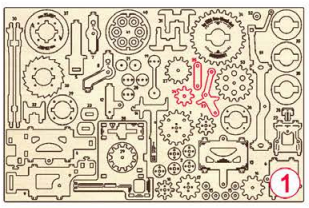
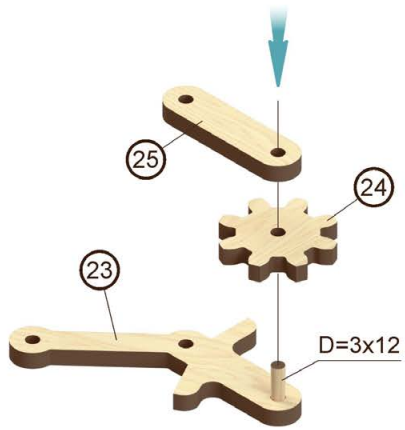

14

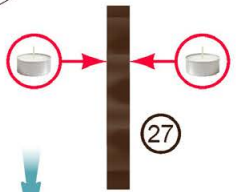
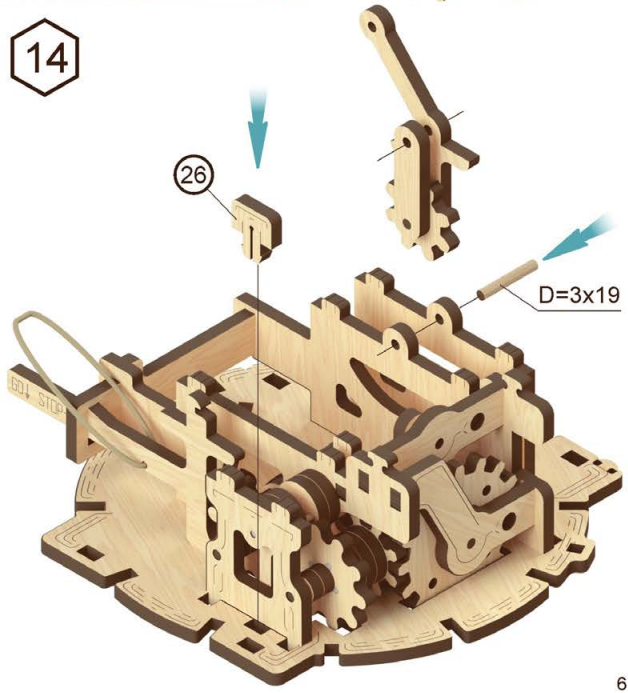

15

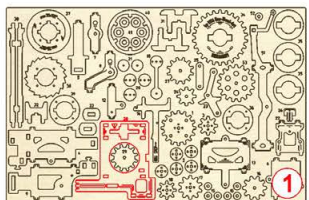
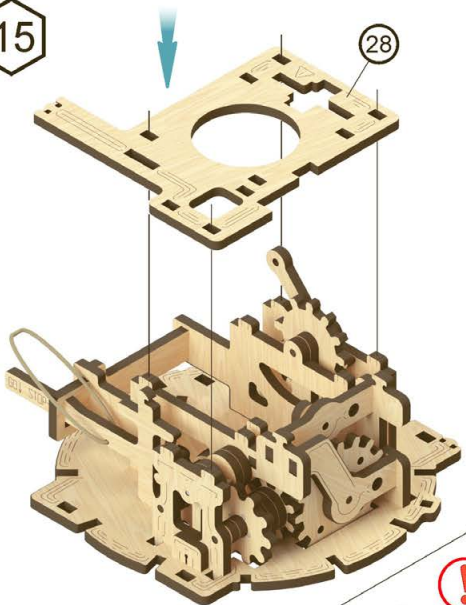

16

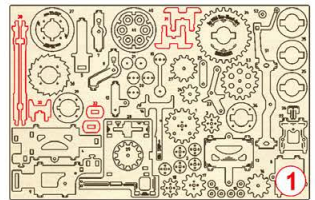
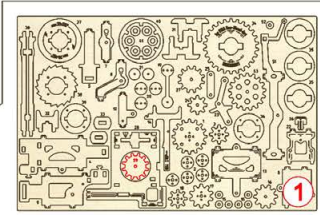
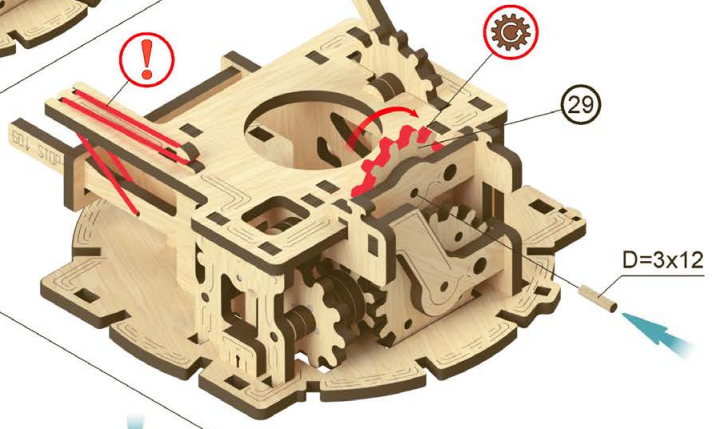
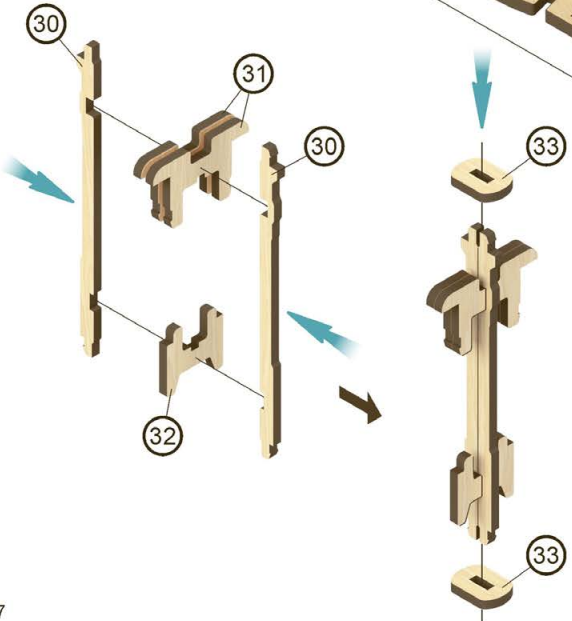

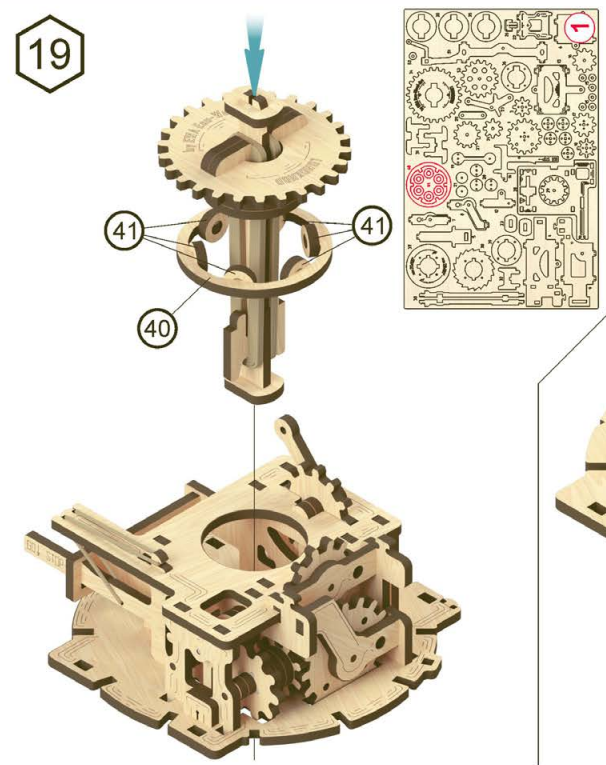
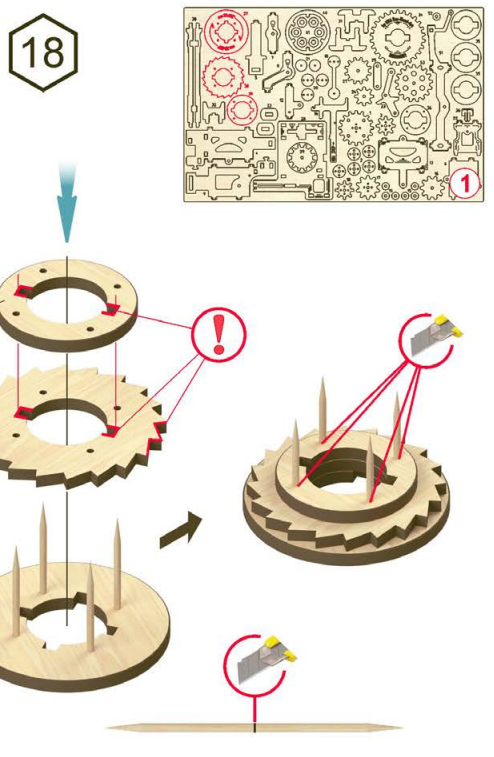
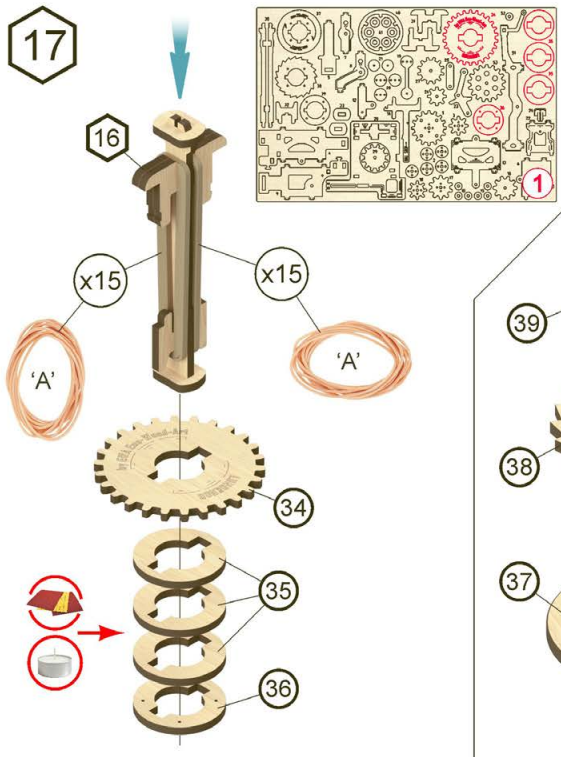

21

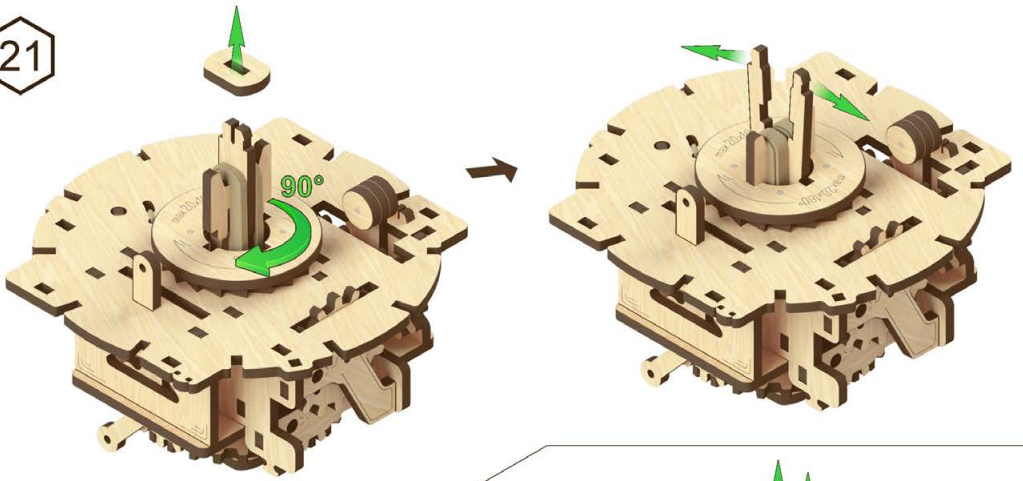

22

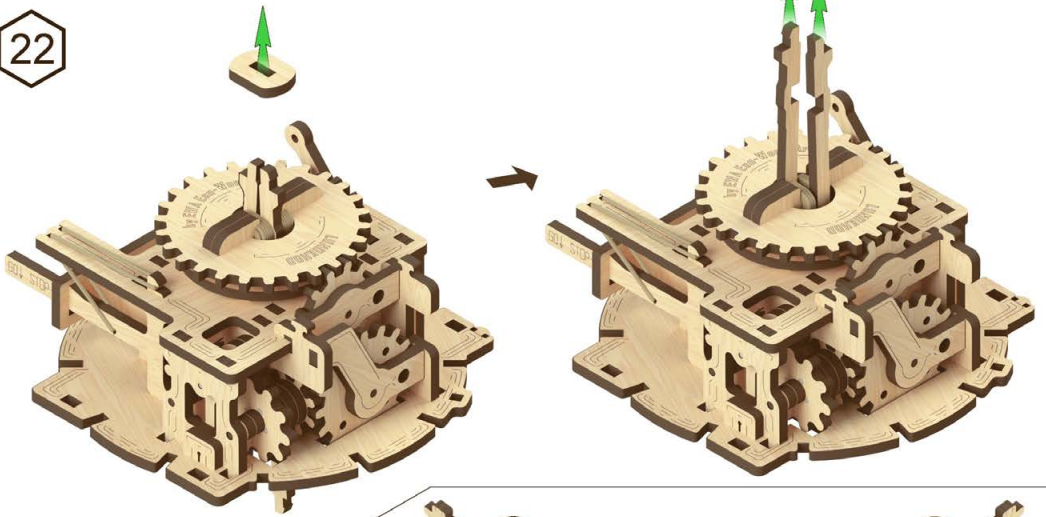

23

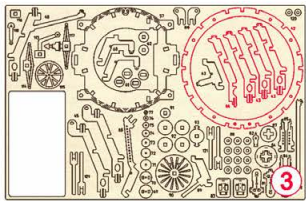
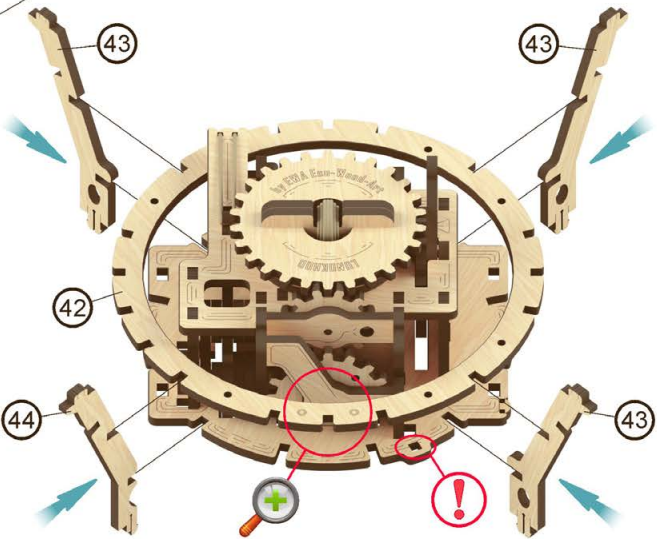

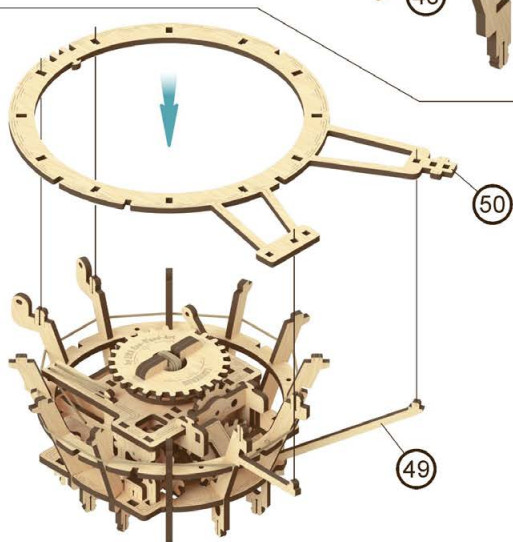
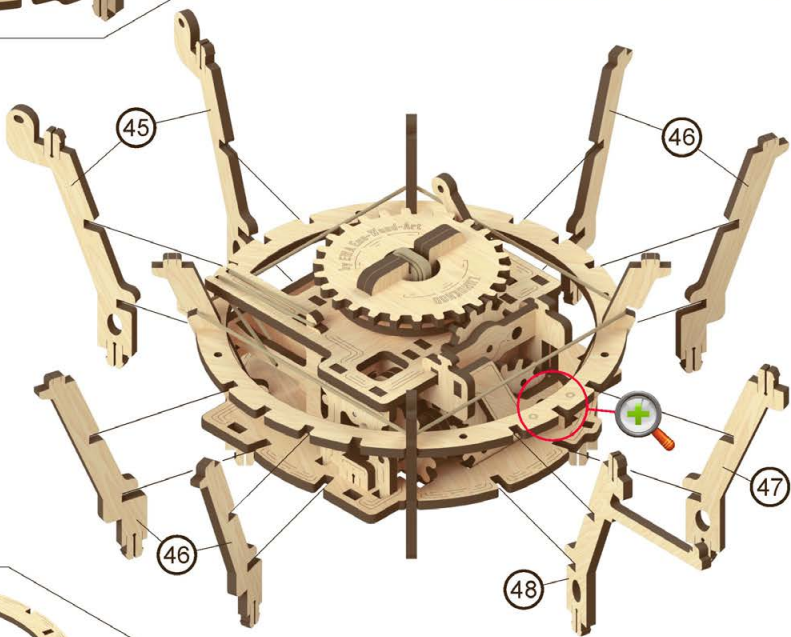
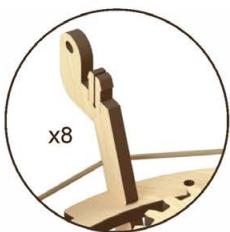
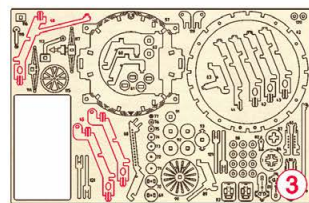
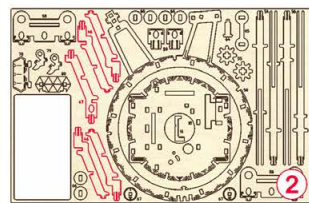
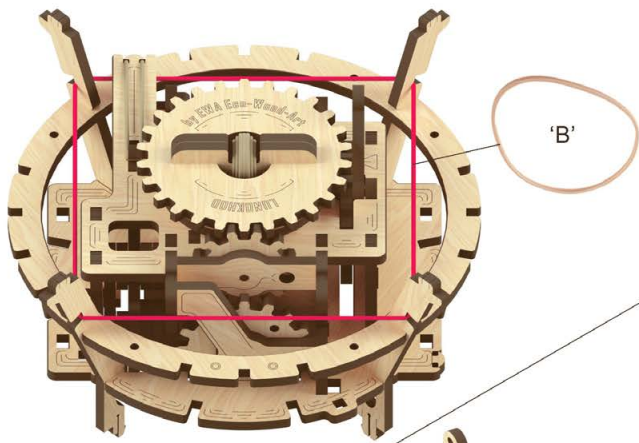

26

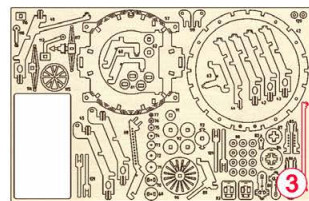
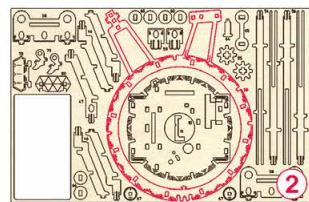

27

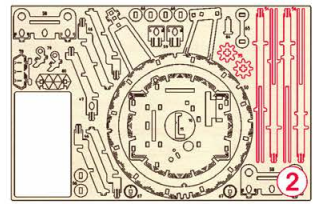
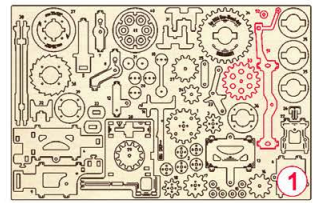
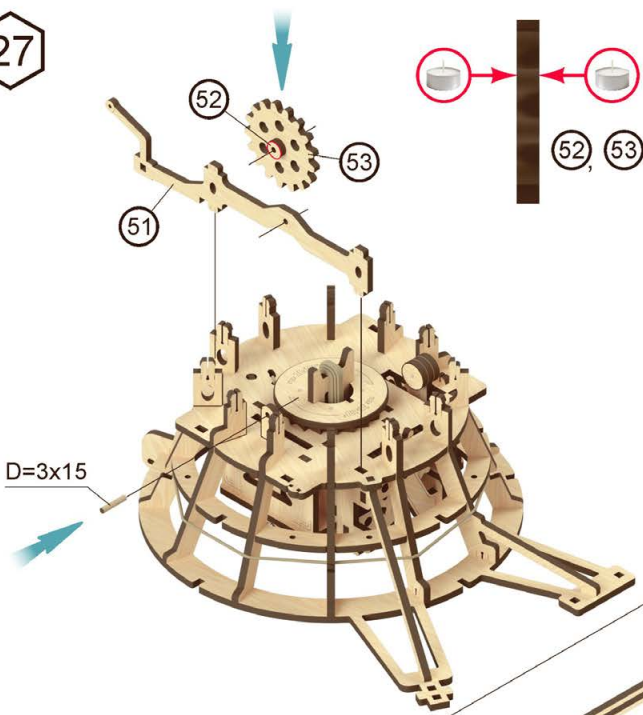

28 x2

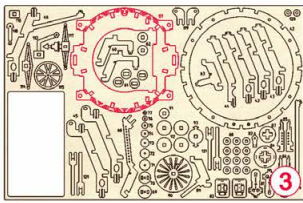

29

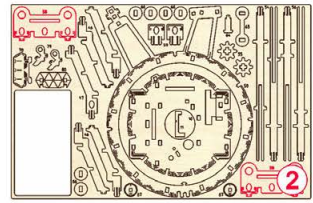
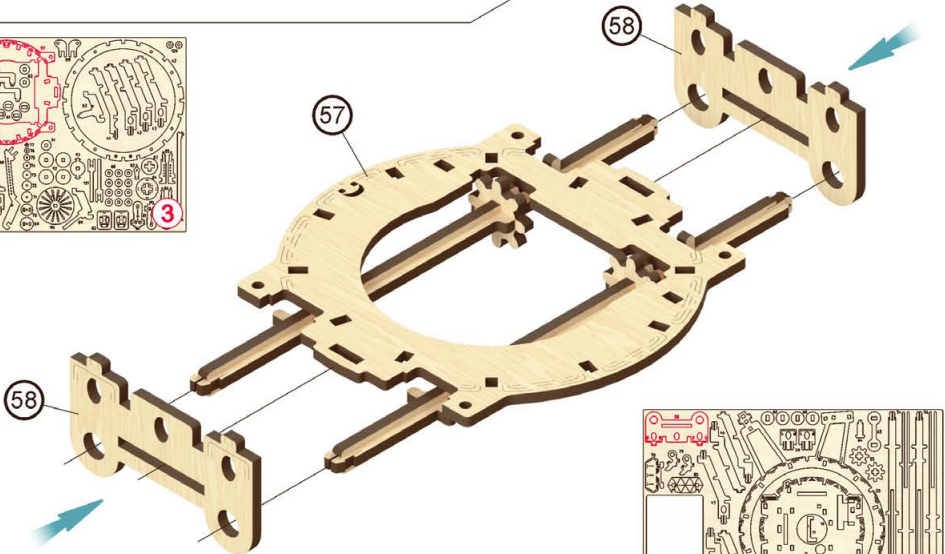

30

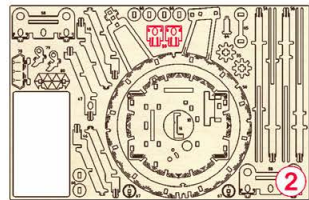
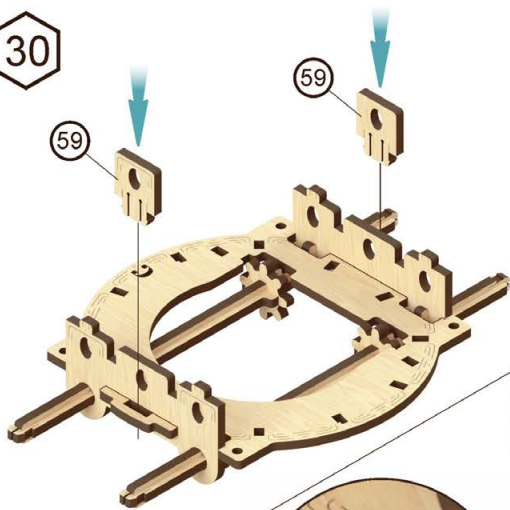

31

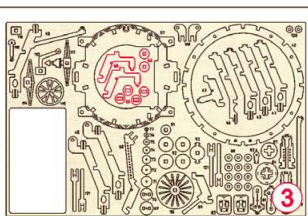
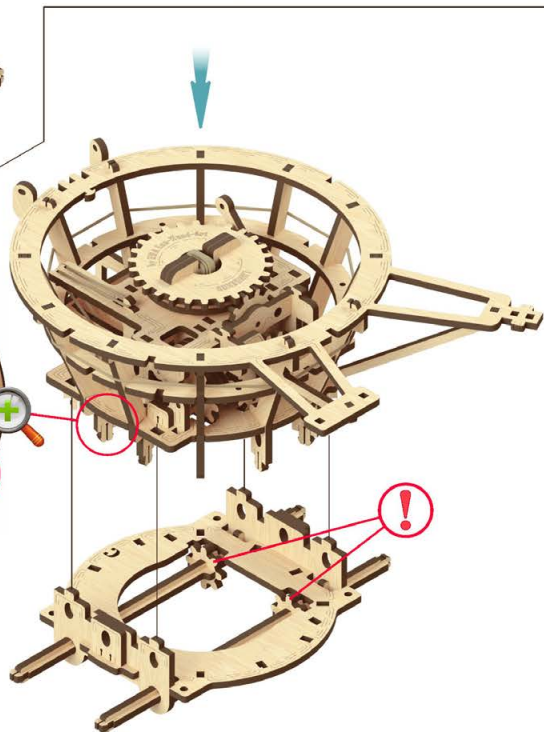
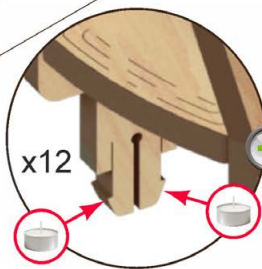

32 x2

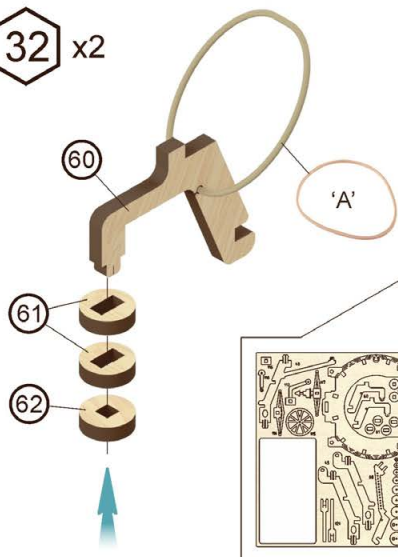

33

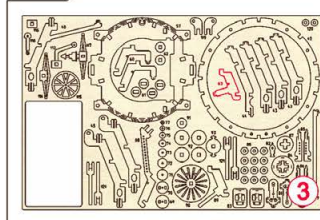
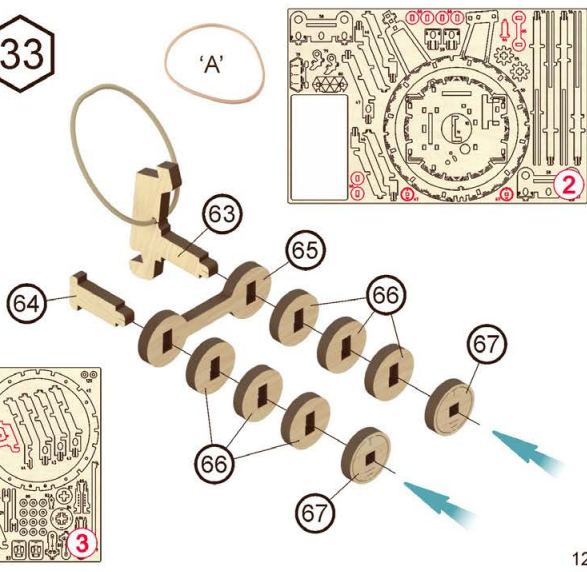

34

- 77
- 76
- 75
- 74
- 73
- 72
- 71
- 70

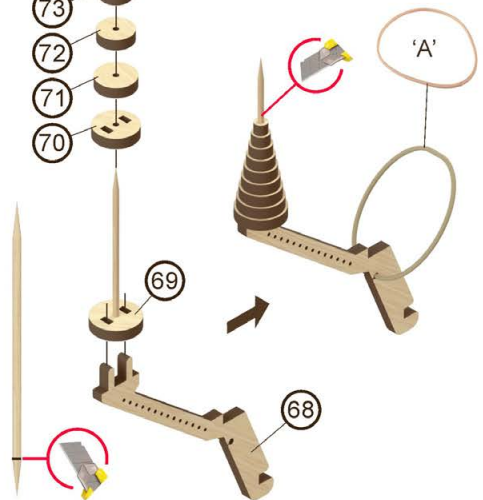
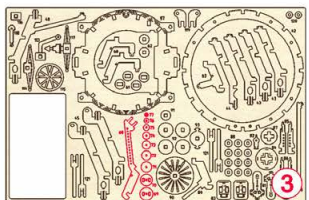

35

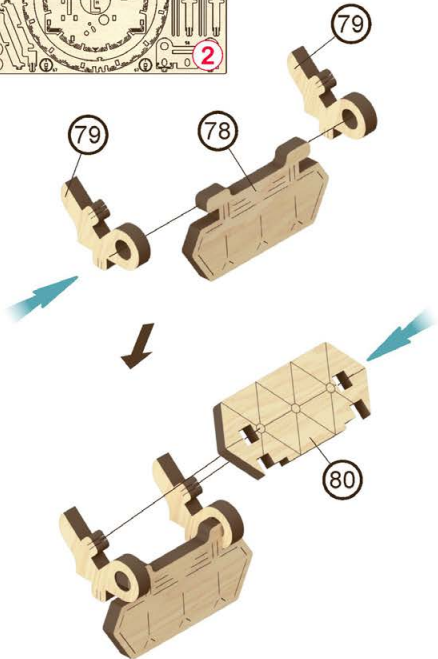
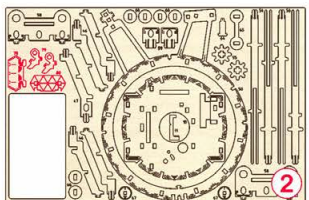

36

- 34
- 35

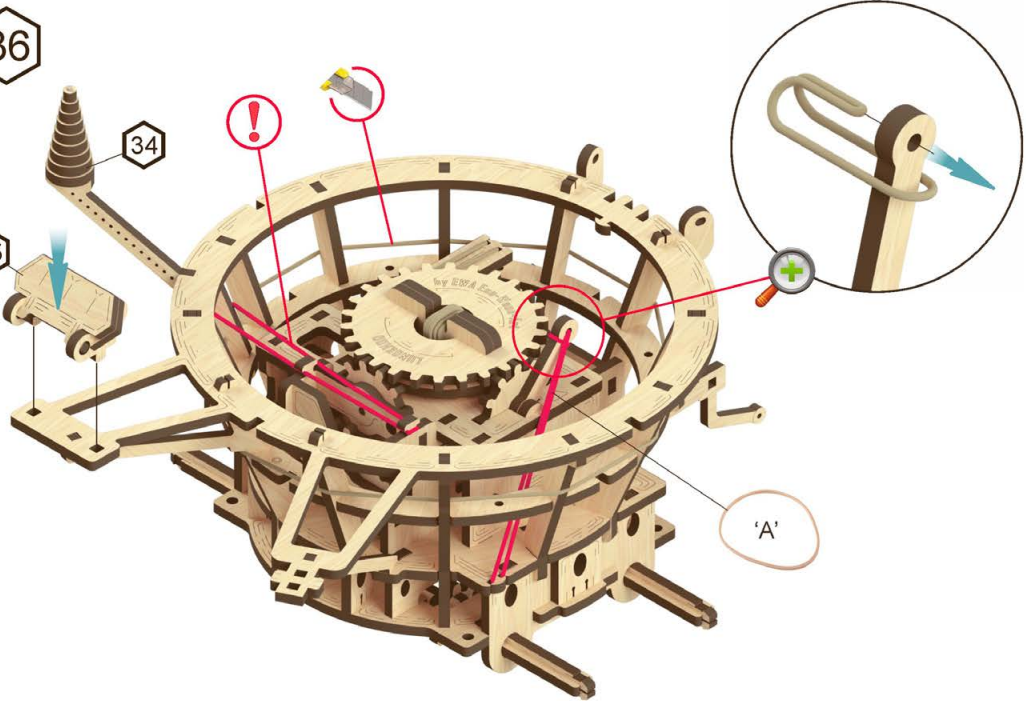

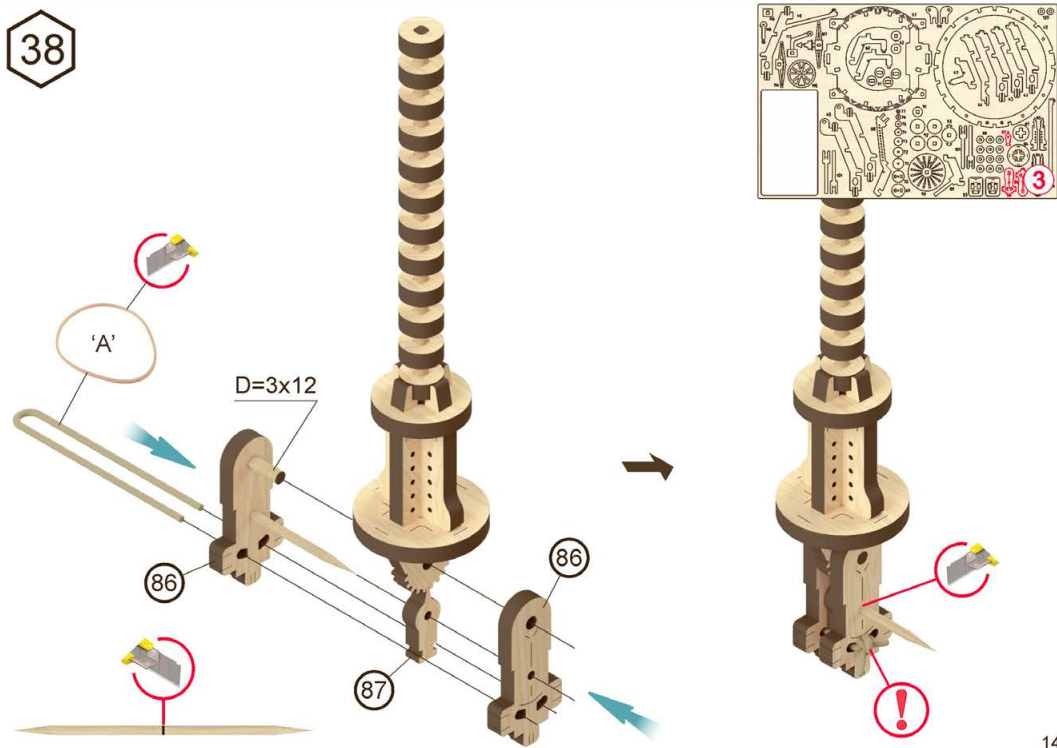
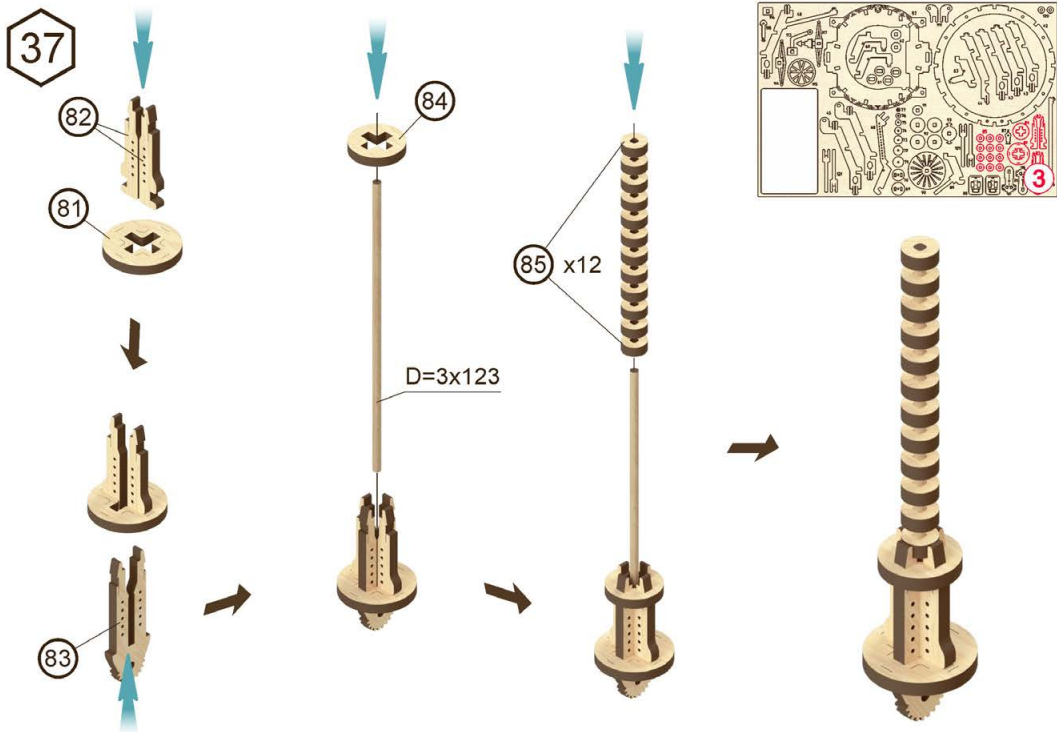

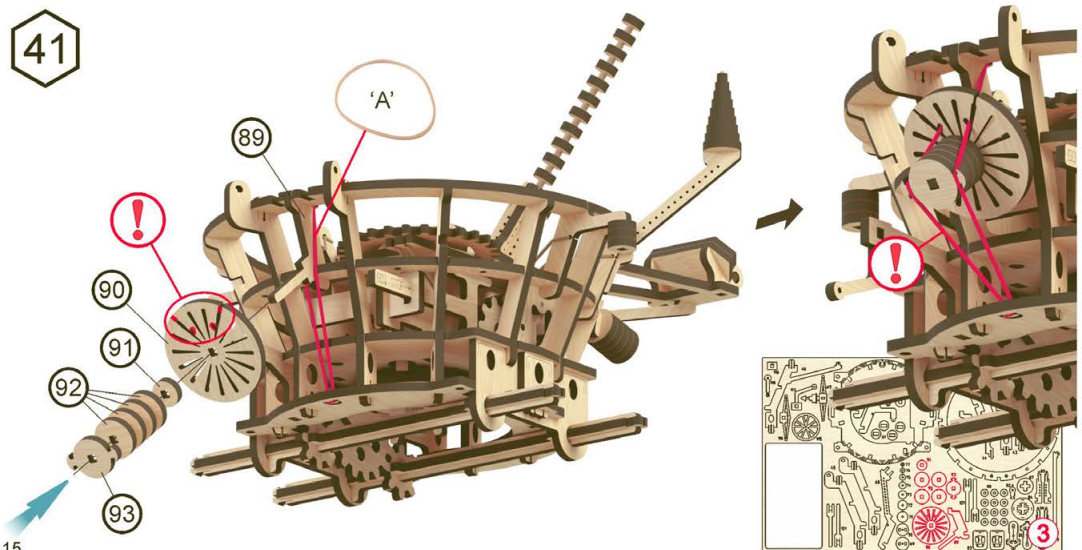
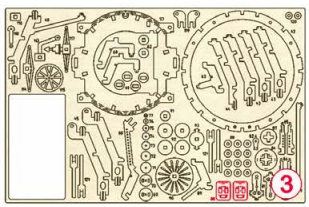
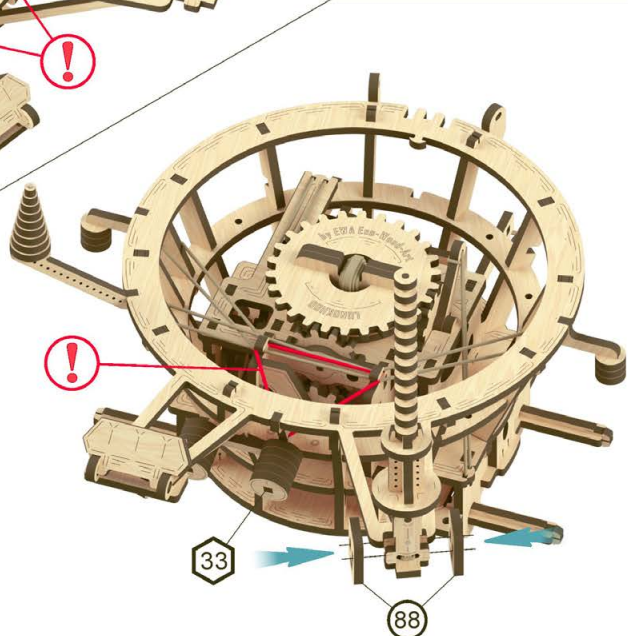
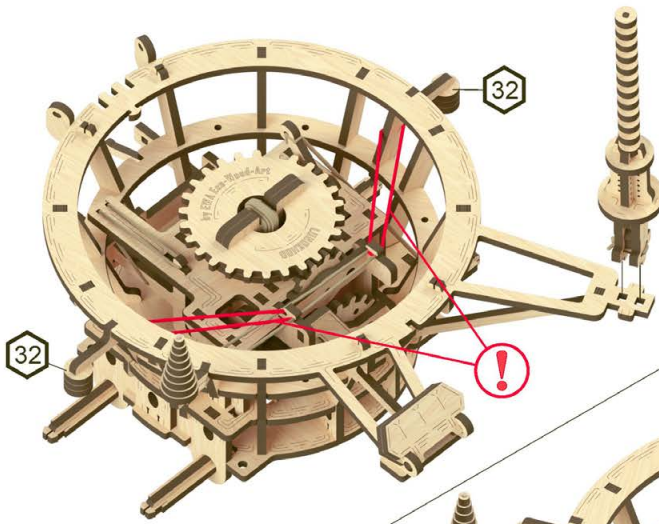

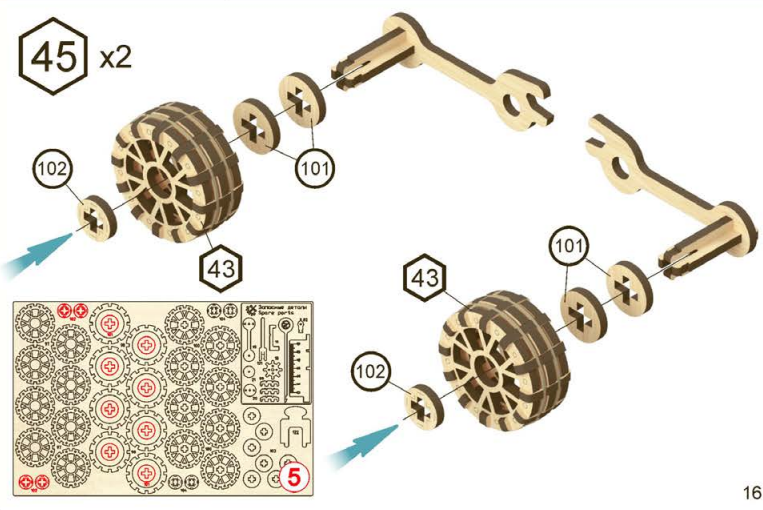
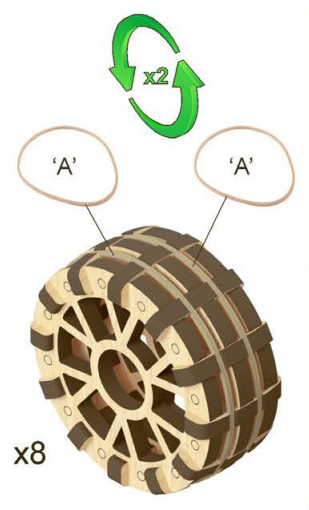
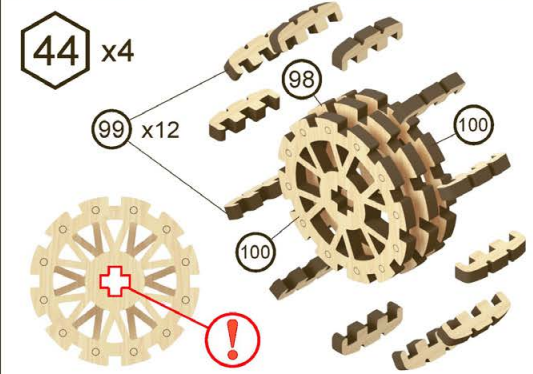
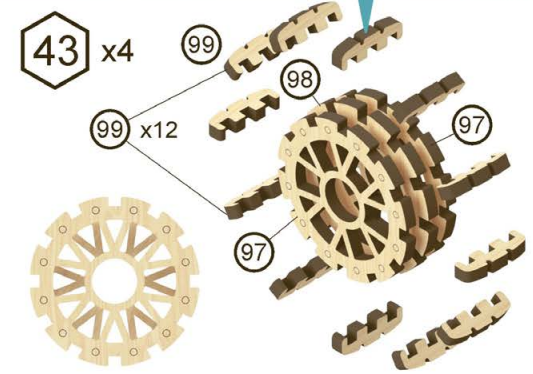
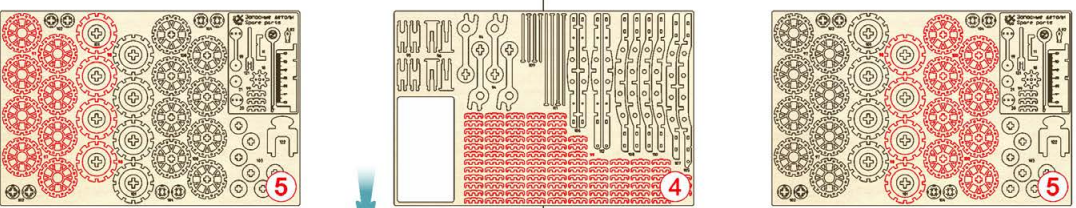
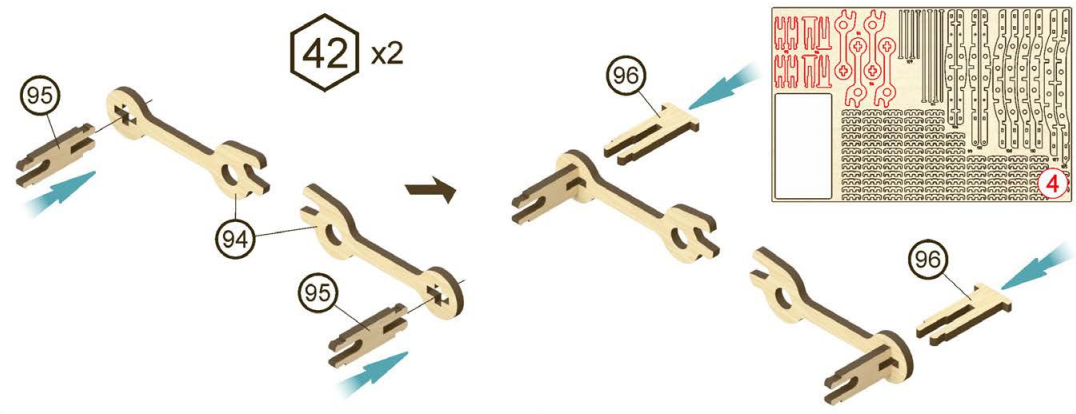

46

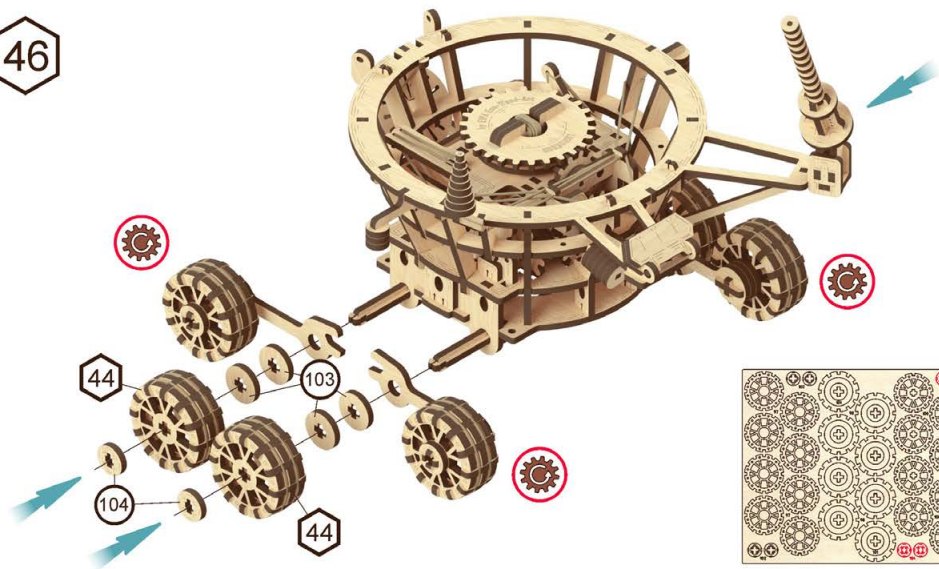

47

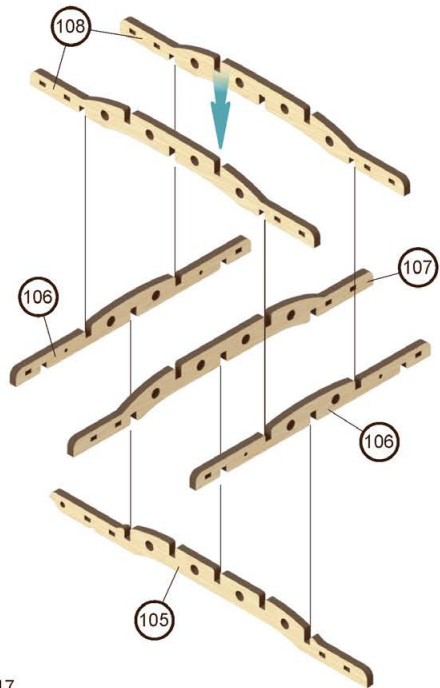
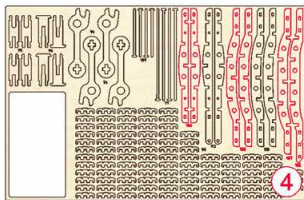

48

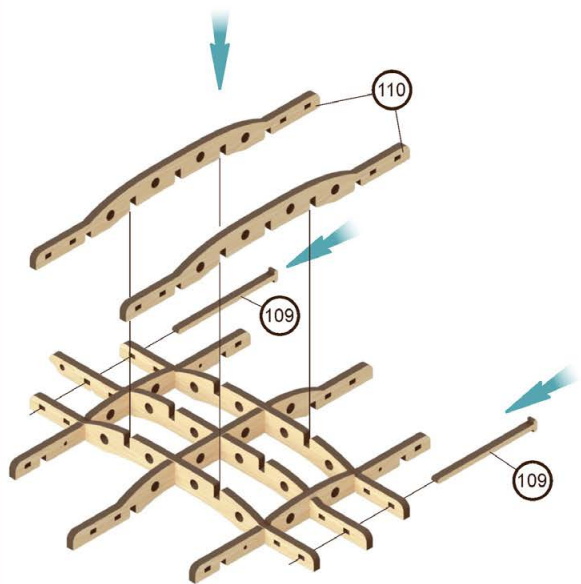
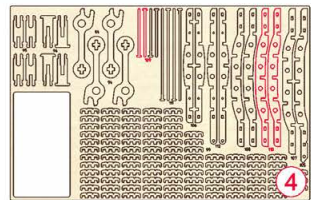

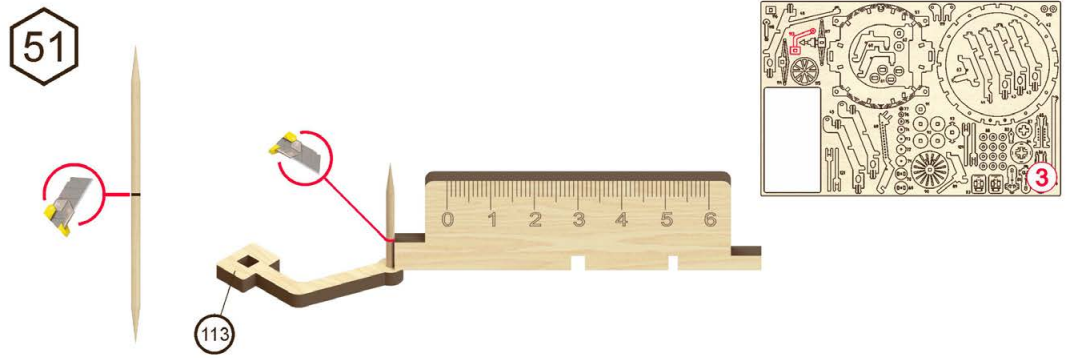
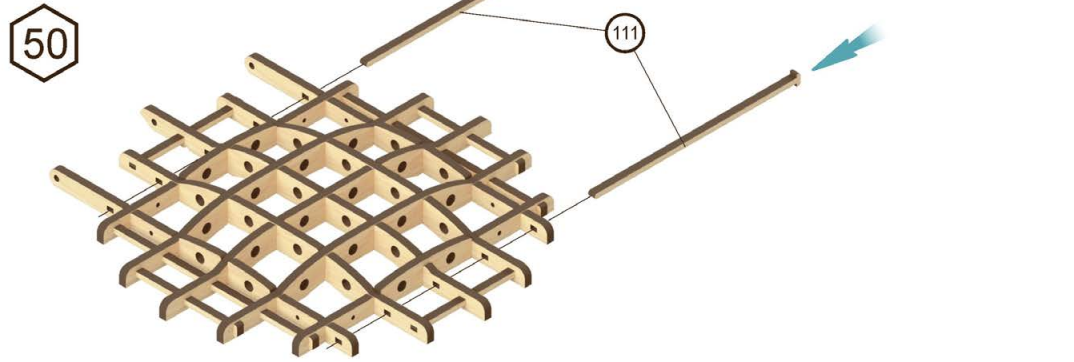
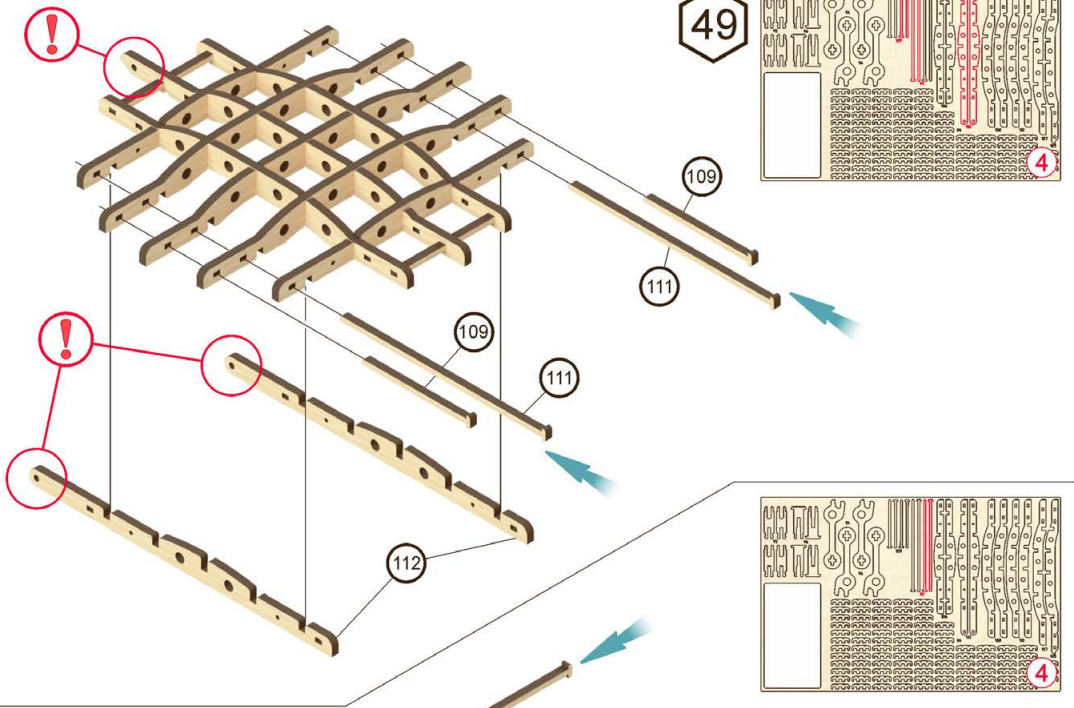

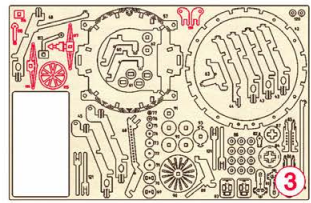
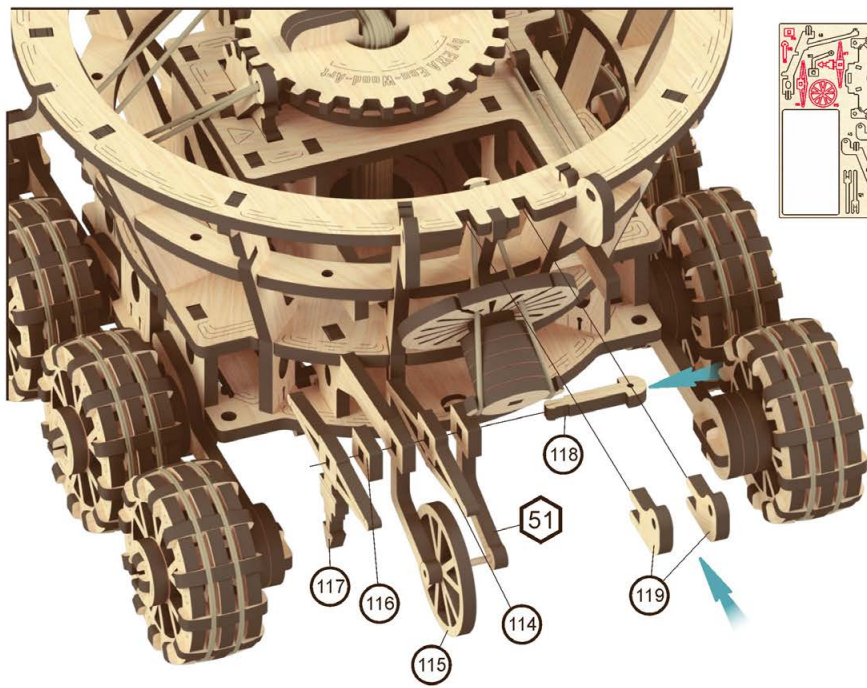

52

53

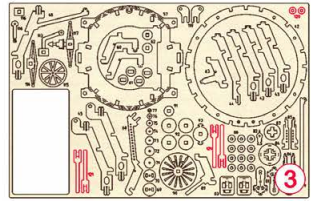
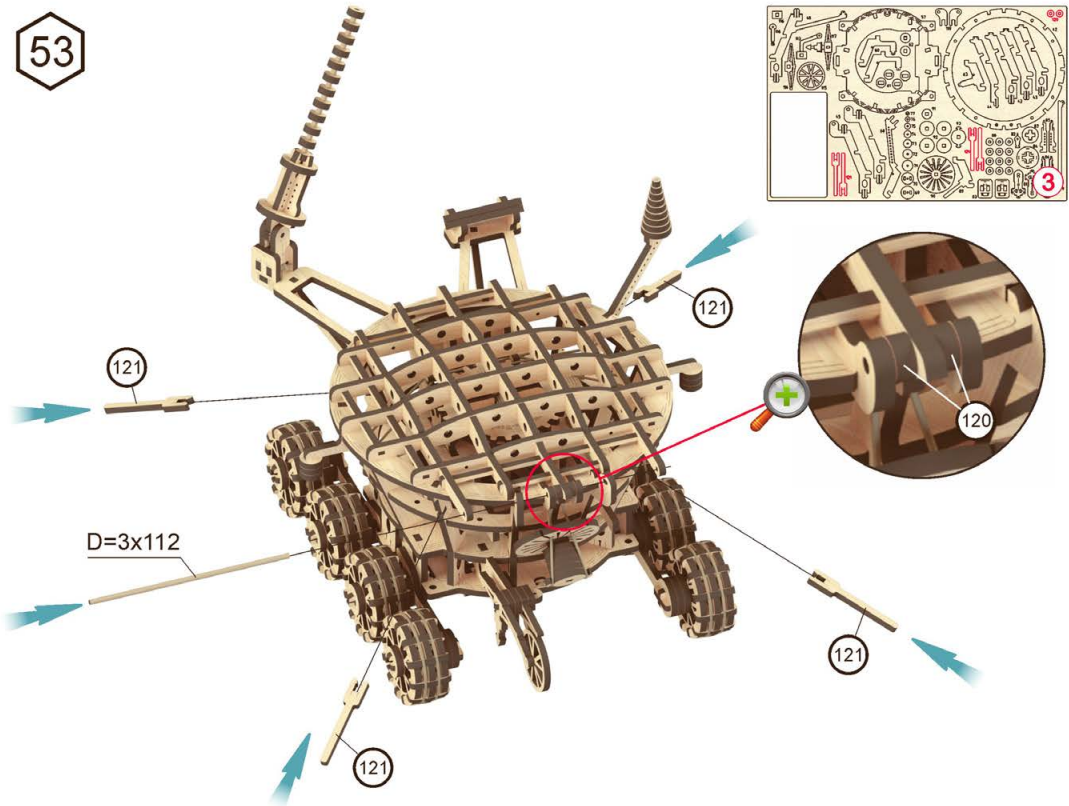

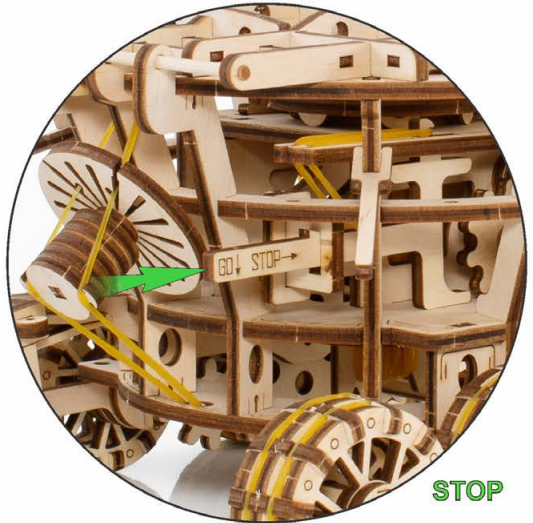
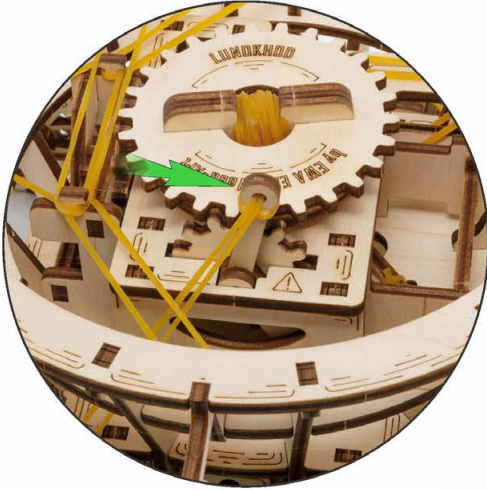

STOP

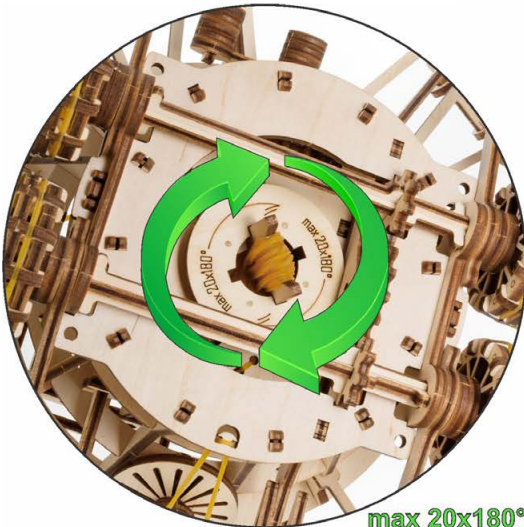

max 20x180°

