

# Assembly Instruction



# Icosahedral Globe



## Запасные детали Spare parts

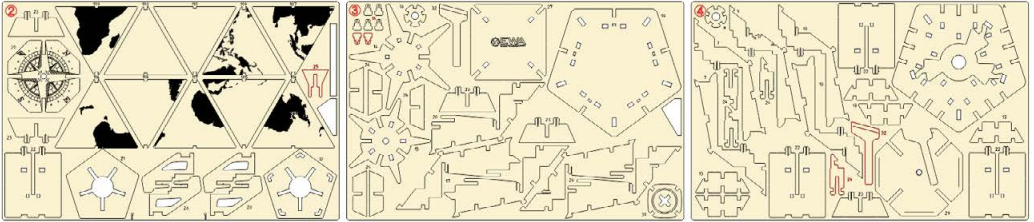

EN Wax it with a candle  
 PL Posmaruj za pomocą świecy parafinowej  
 FR Graisser avec une bougie de paraffine  
 ES Engrasar con ayuda de una vela de parafina  
 DE Mit einer Kerze wachsen  
 RU Смазать парафиновой свечой  
 IT Lubrificare con candela di paraffina  
 CN 用干蜡烛上蜡润滑  
 CZ Navoskujte svíčkou



EN Details should rotate freely  
 PL Swobodne obracanie  
 FR Libre rotation  
 ES Rotación libre  
 DE Auf freie Rotation achten  
 RU Свободное вращение  
 IT Rotazione libera  
 CN 流畅地旋转  
 CZ Části by se měly volně otáčet



EN Remove the burrs with sandpaper  
 PL Usunąć zadziory papierem ściernym  
 FR Retirer les bavures avec du papier à polir  
 ES Quitar las rebabas con el papel esmeril  
 DE Grate mit Schleifpapier entfernen  
 RU Удалить заусенцы наждачной бумагой  
 IT Sbavare con carta vetrata  
 CN 用砂纸去除毛刺。  
 CZ Vyhlaďte smrkových papírem



EN Pay attention  
 PL Uwaga  
 FR Faire attention  
 ES Prestar atención  
 DE Achtung  
 RU Уделить внимание  
 IT Prestare attenzione  
 CN 请注意  
 CZ Pozor

**EN** The manufacturer reserves the right to make changes in the design of the product, not worsening its technical characteristics. Information about the changes made may not be present in this manual.

**PL** Producent zastrzega sobie prawo do zmiany konstrukcji wyrobu bez pogorszenia jego właściwości technicznych. Niniejsza instrukcja może nie zawierać informacji o zmianach.

**FR** Le producteur se réserve le droit d'apporter des modifications dans la construction du produit à condition si elles ne portent atteinte à ses caractéristiques techniques. Les renseignements sur les modifications apportées peuvent ne pas être dans la présente notice.

**ES** El fabricante se reserva el derecho de introducir modificaciones en la construcción del producto, que no empeoran sus características técnicas. Datos sobre modificaciones introducidas pueden no aparecer en esta instrucción.

**DE** Der Hersteller behält sich das Recht auf Designänderungen, die die technischen Merkmale und Funktionen nicht negativ beeinflussen, vor.

**RU** Производитель оставляет за собой право вносить изменения в конструкцию изделия, не ухудшающие его технические характеристики. Сведения о внесенных изменениях могут отсутствовать в настоящей инструкции.

**IT** Il produttore si riserva il diritto di apportare modifiche al design del prodotto, non peggiorando le sue caratteristiche tecniche. Informazioni sulle modifiche apportate potrebbero non essere presenti in questo manuale.

**CN** 制造商保留对产品的设计更改的权利，一切改良旨在增强产品的技术性能。改良处若未出现在手册中，敬请谅解

**CZ** Výrobce si vyhraňuje právo na takové změny v designu produktu, které nebudou mít za následek zhoršení technických vlastností. Informace o změnách nemusí být v návodu uvedeny.

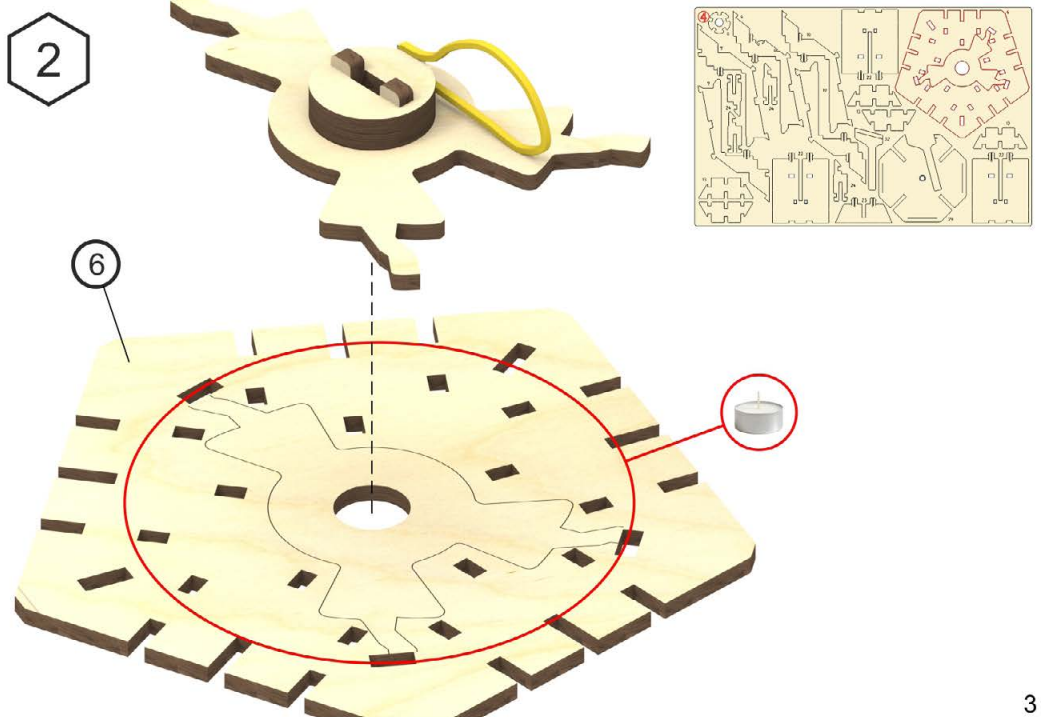
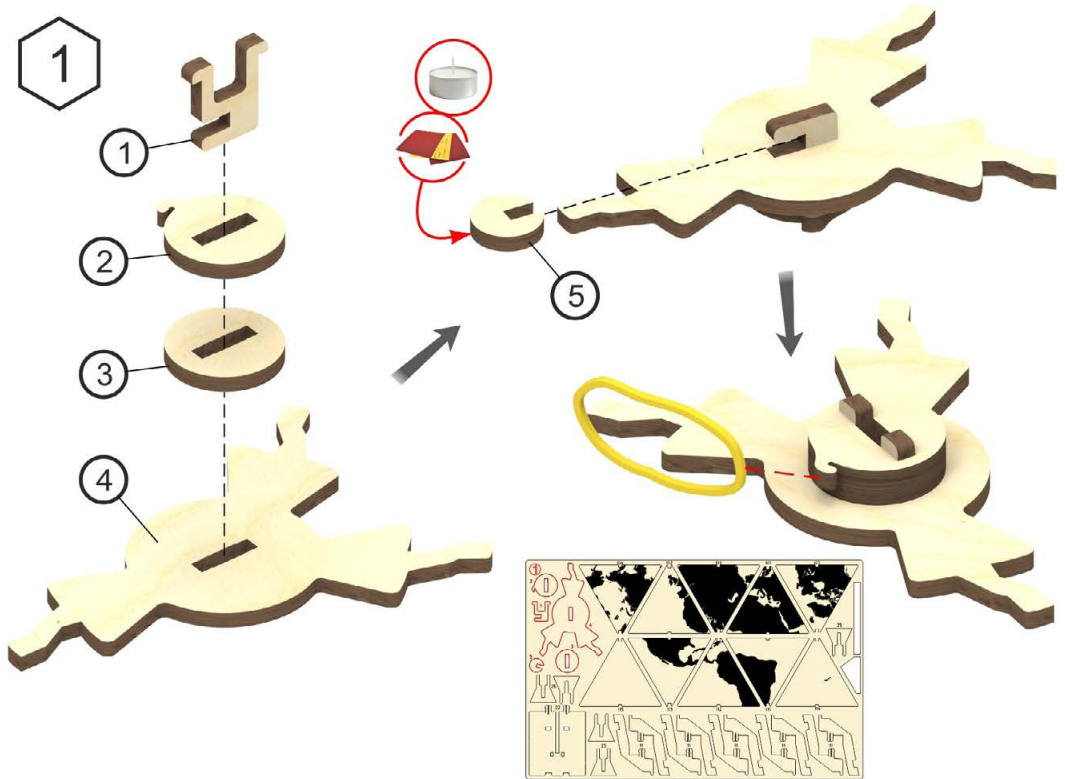

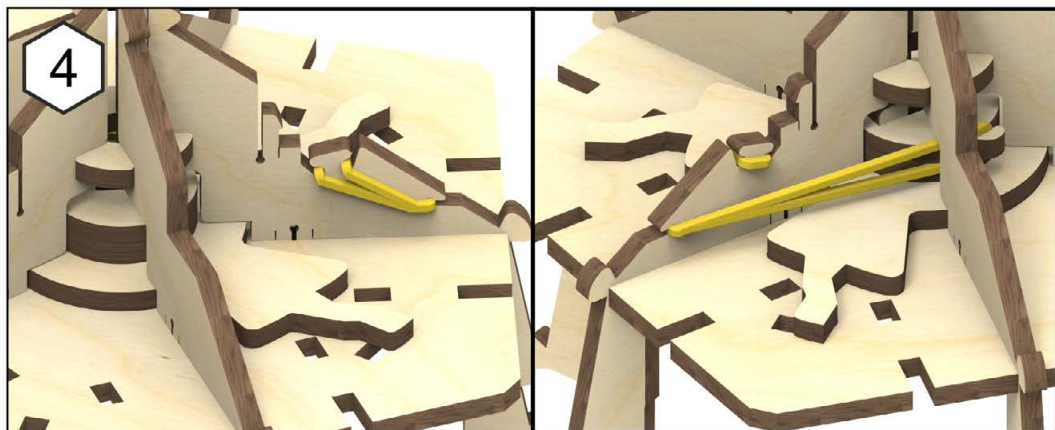
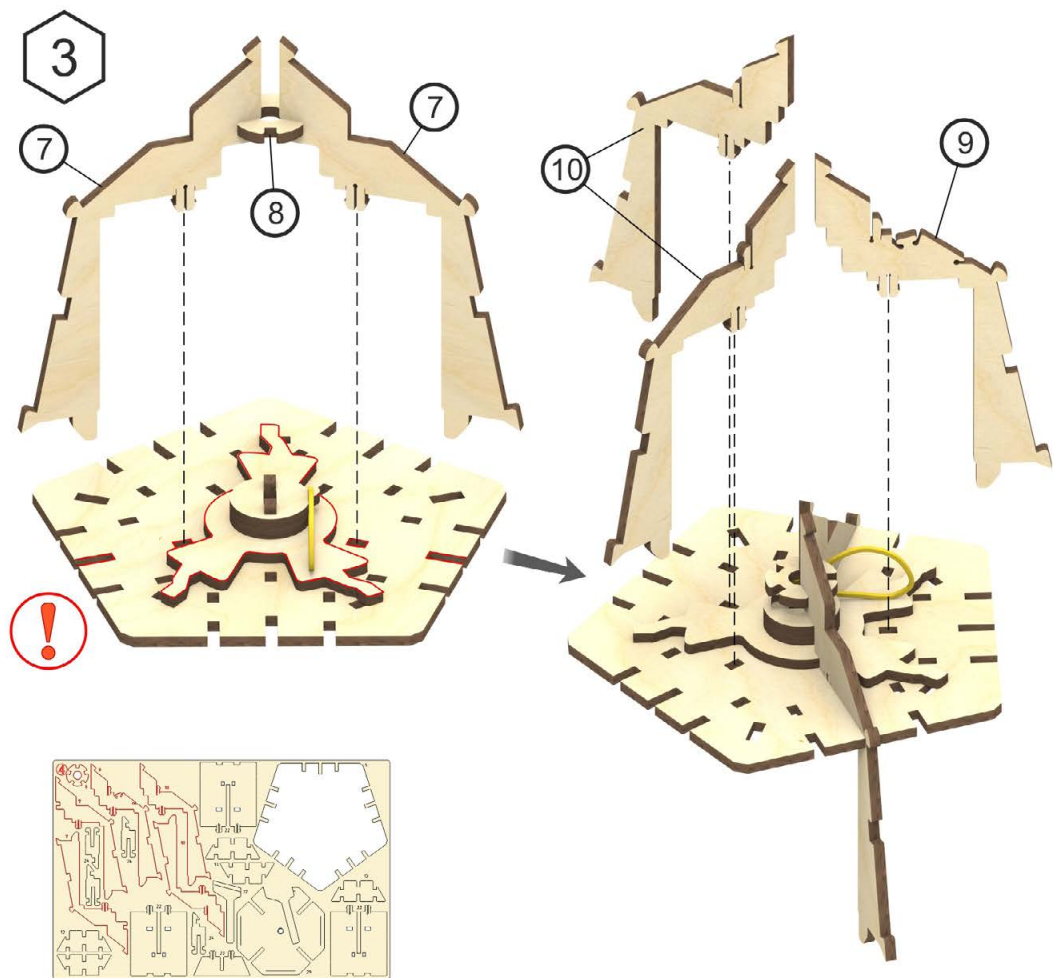

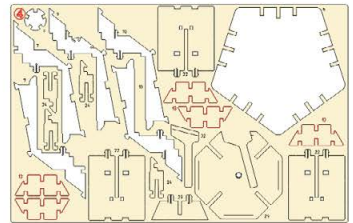
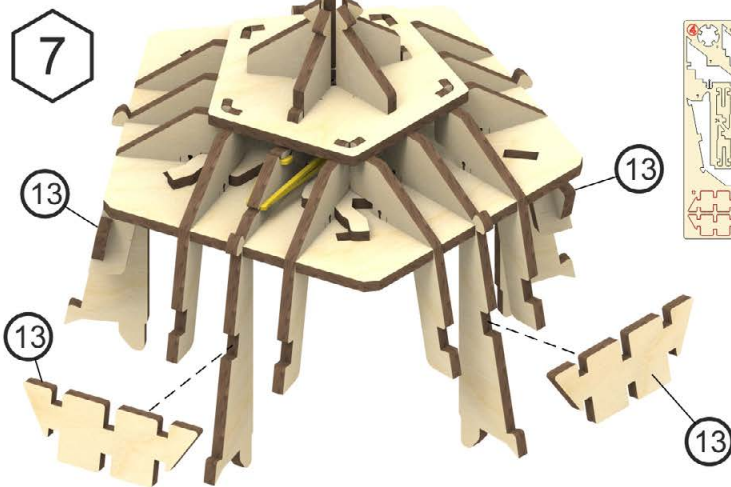
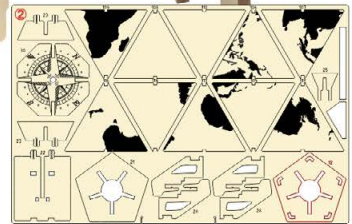
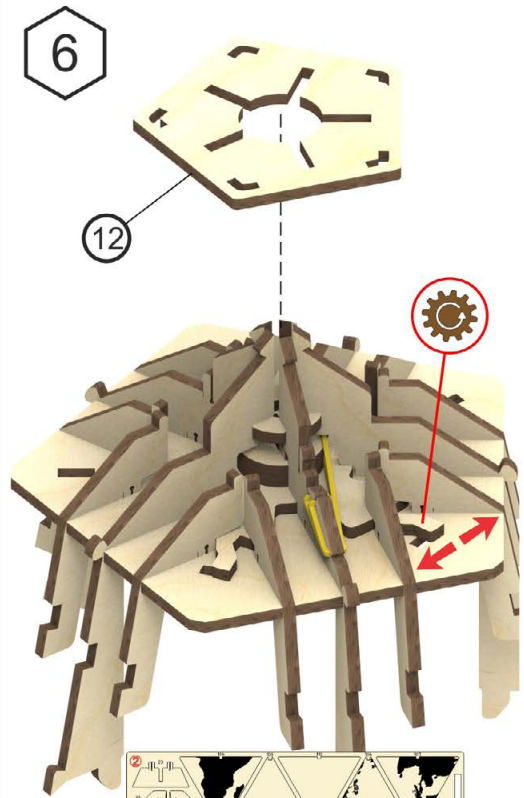
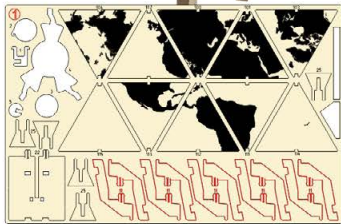
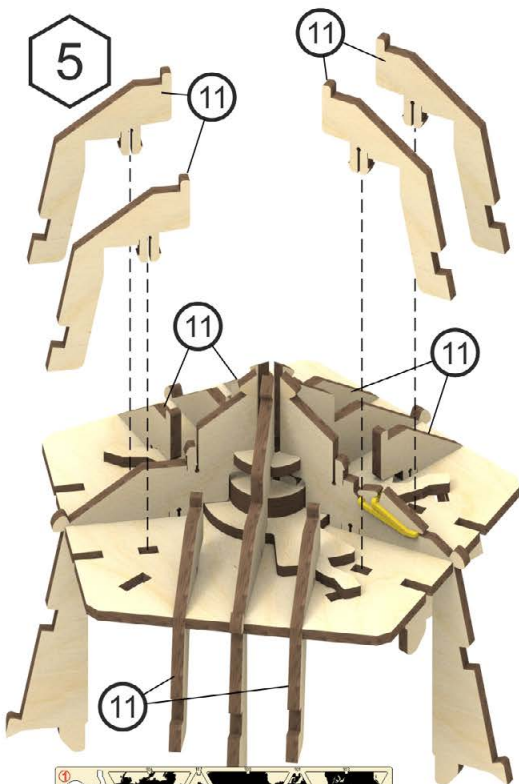

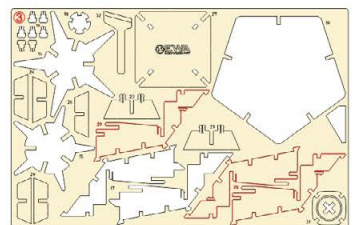
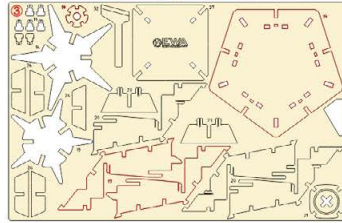
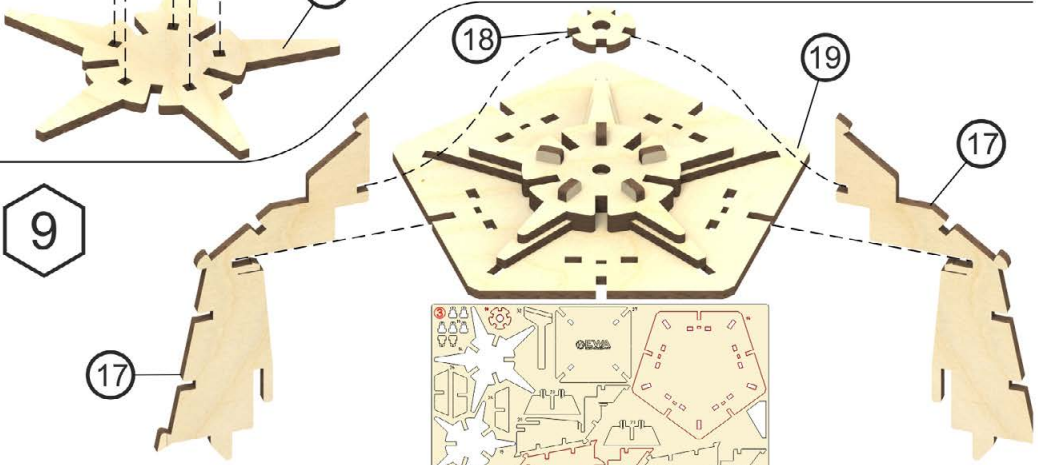
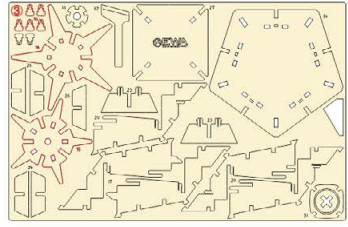
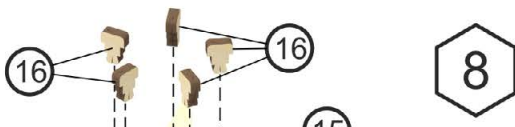

11

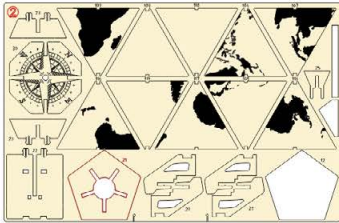
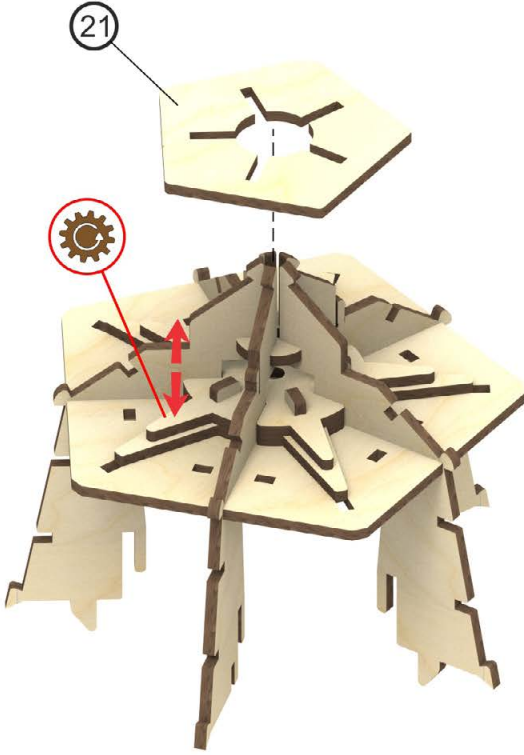

12

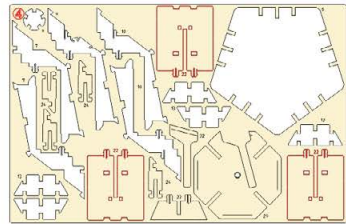
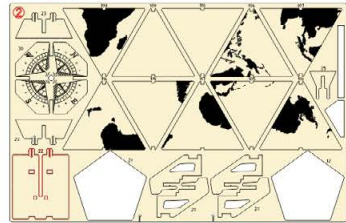
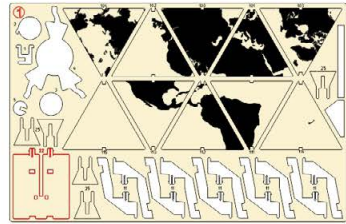
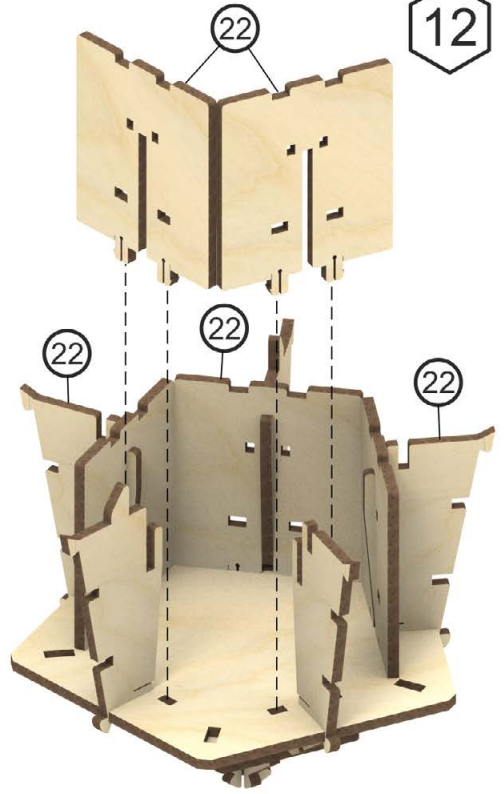

13

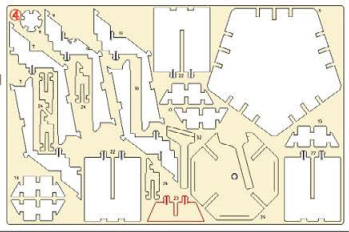
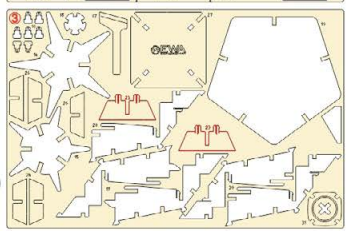
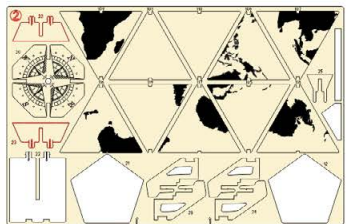
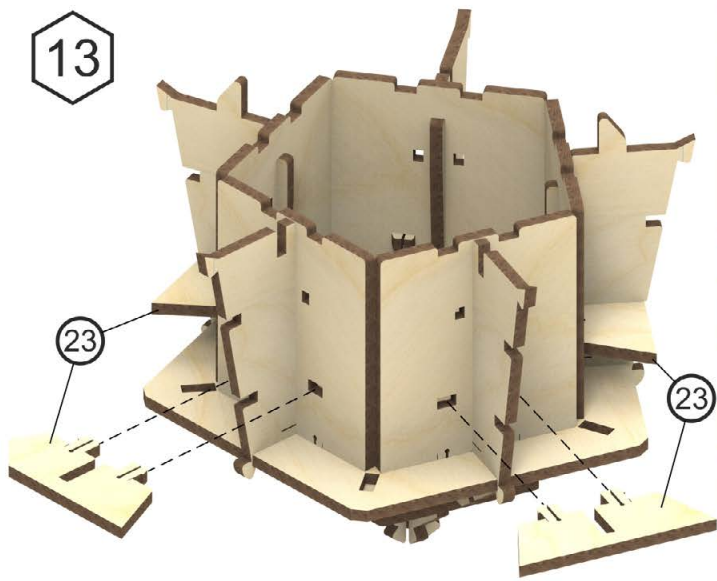

14

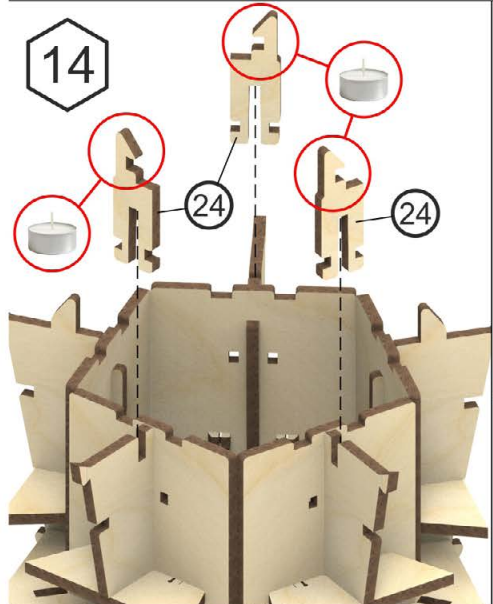

15

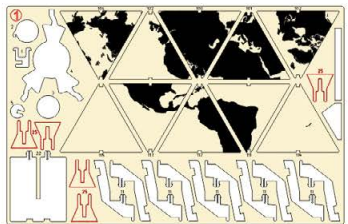
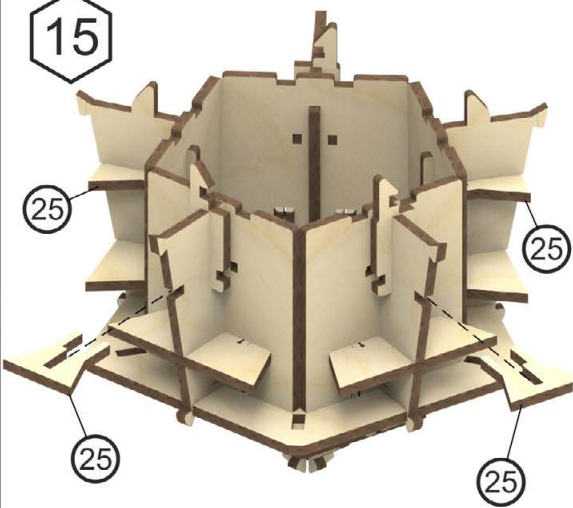

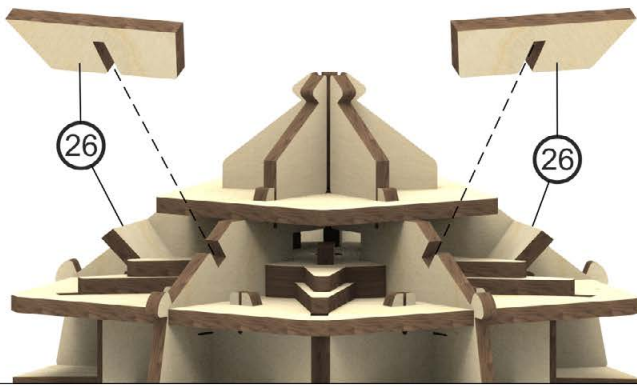

16

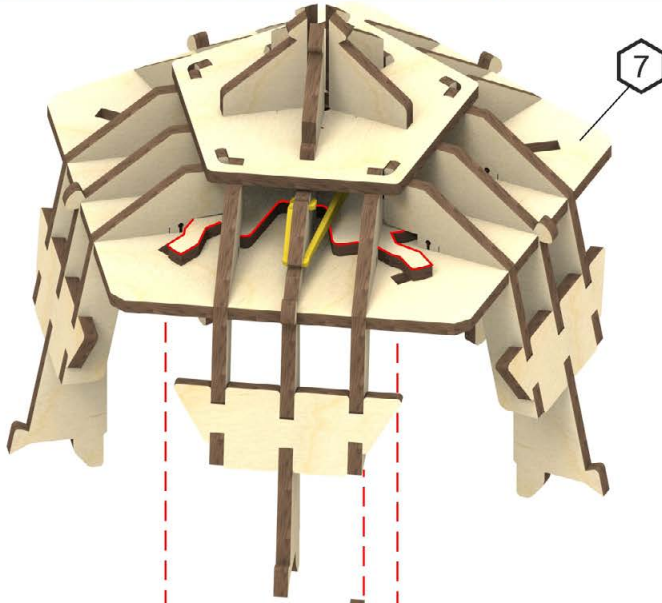
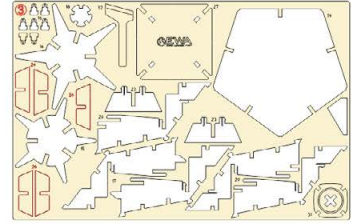

17

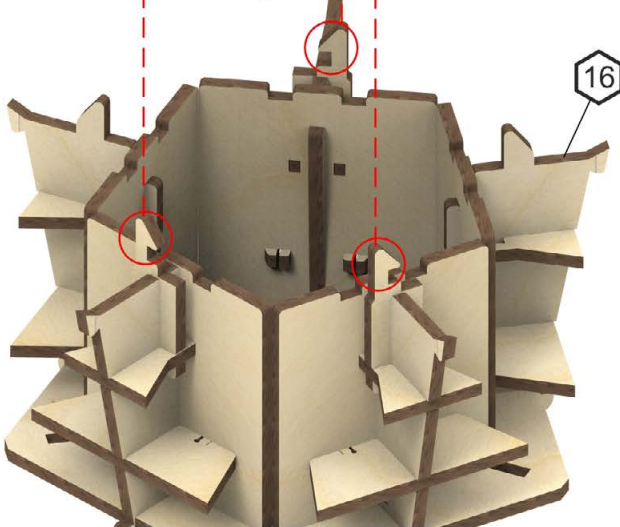

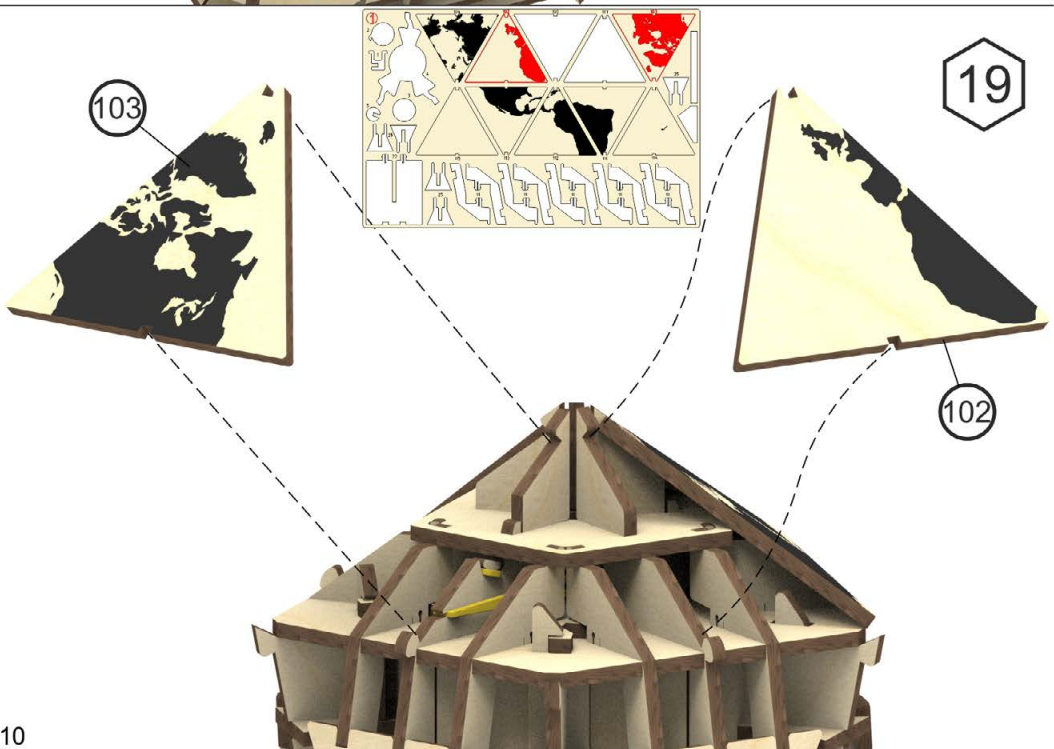
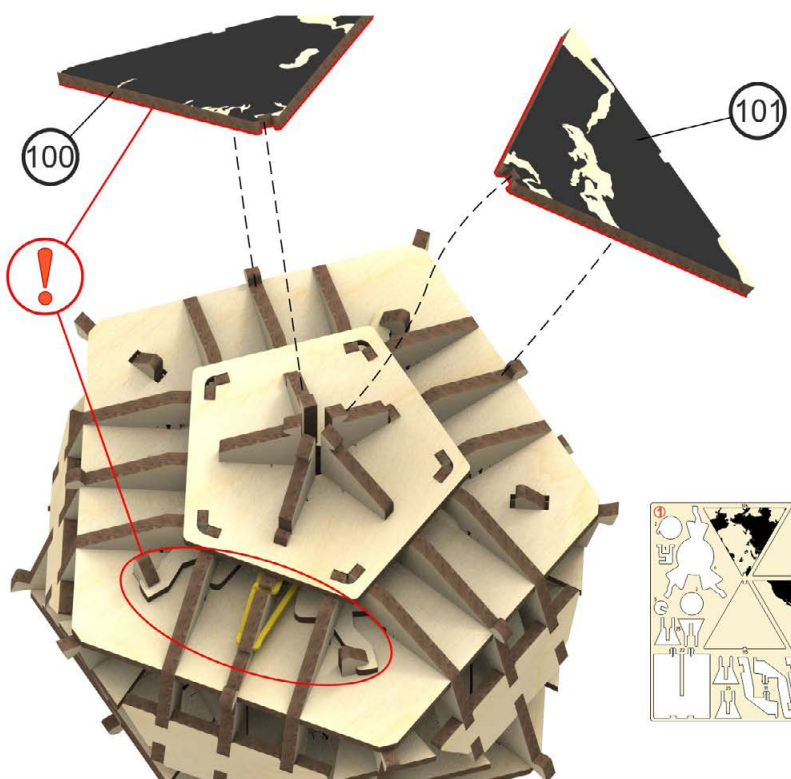

20

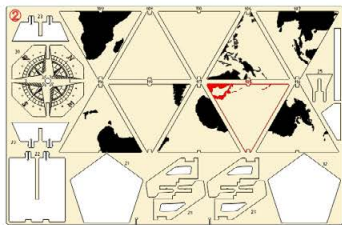
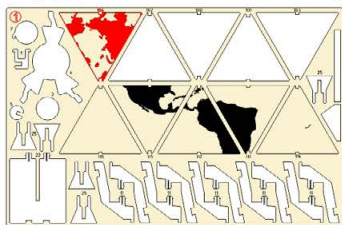
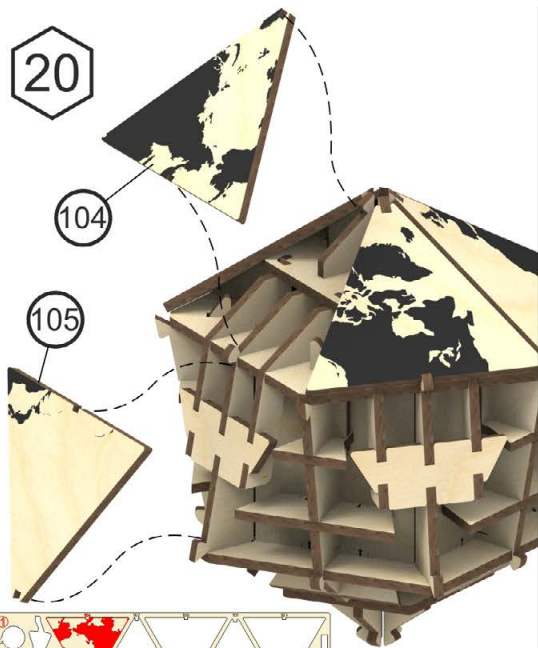

21

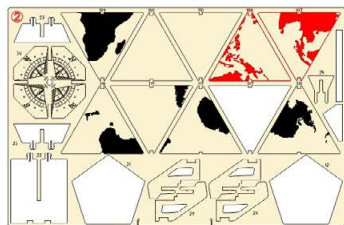
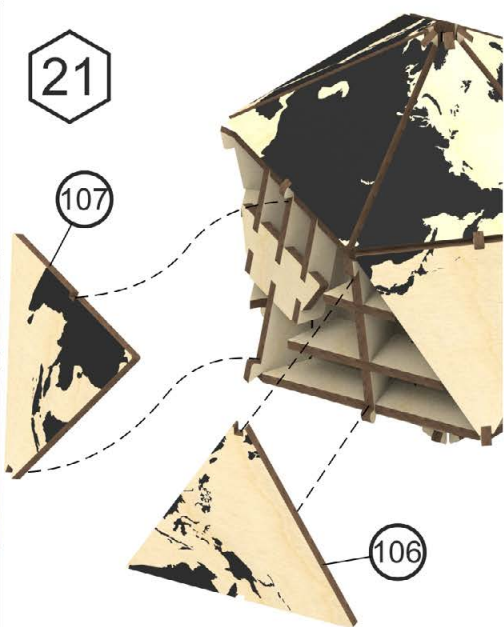

22

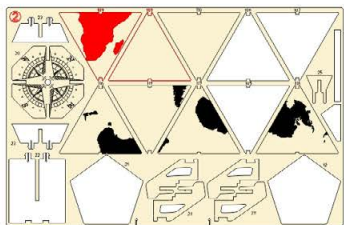
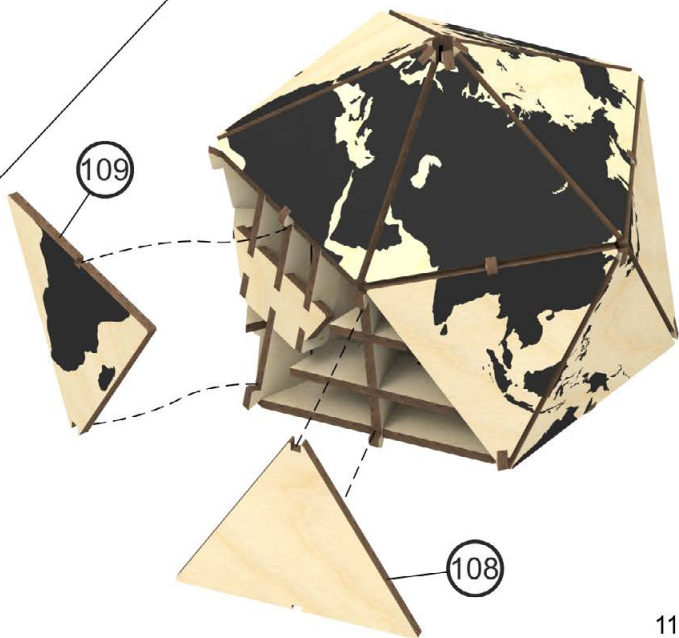

23

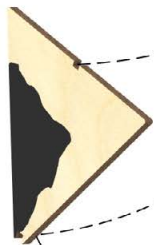

111

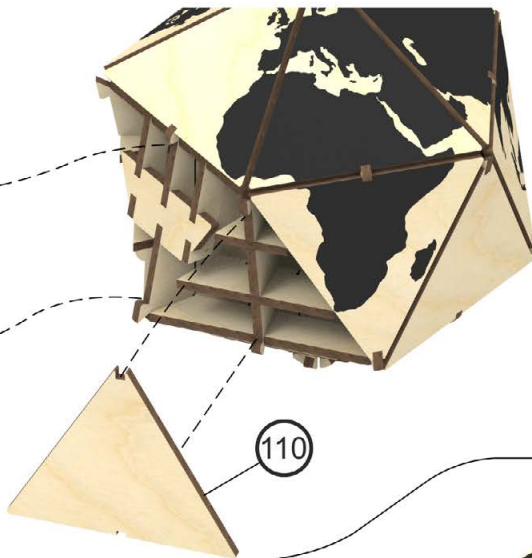

110

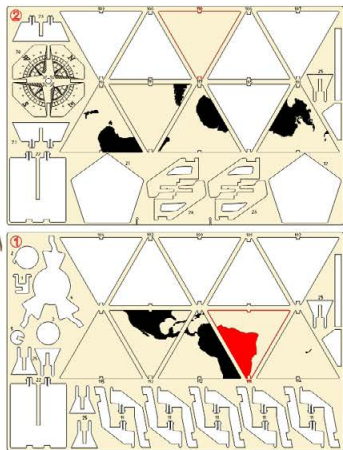

24

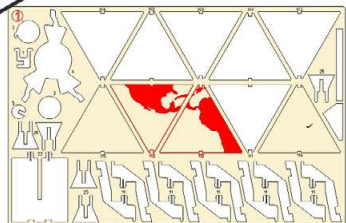

113

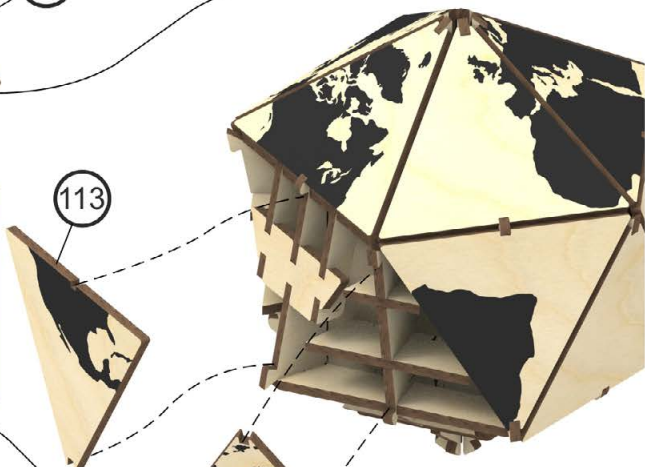

25

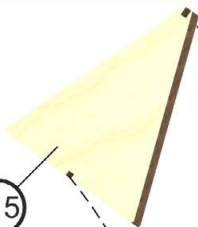

115

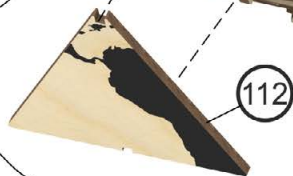

112

114

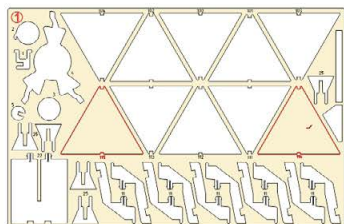
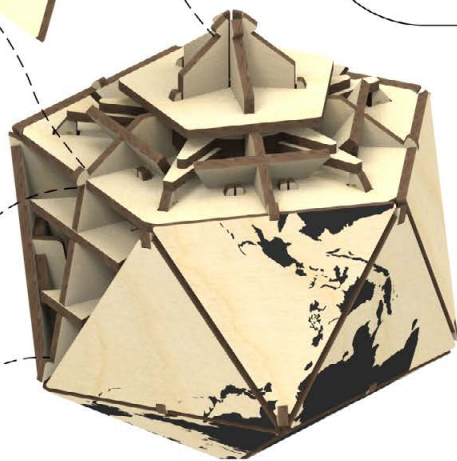
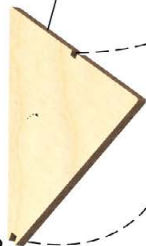

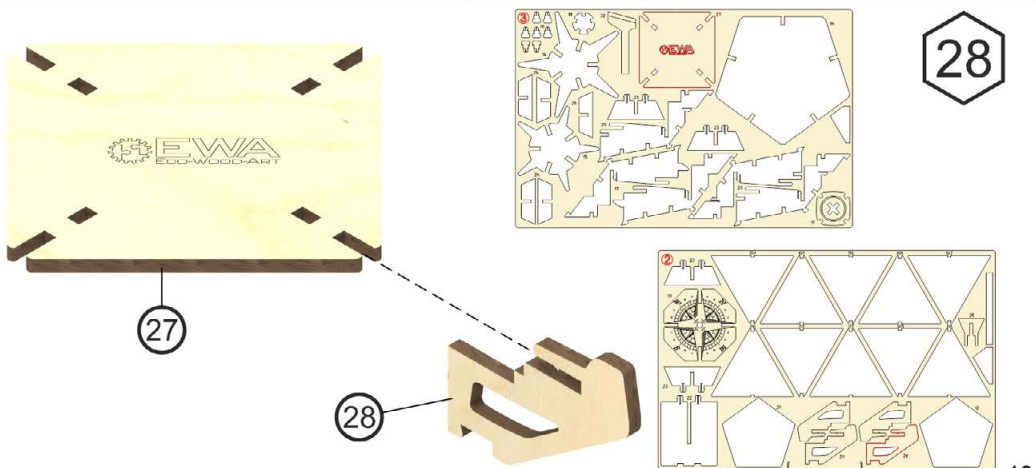
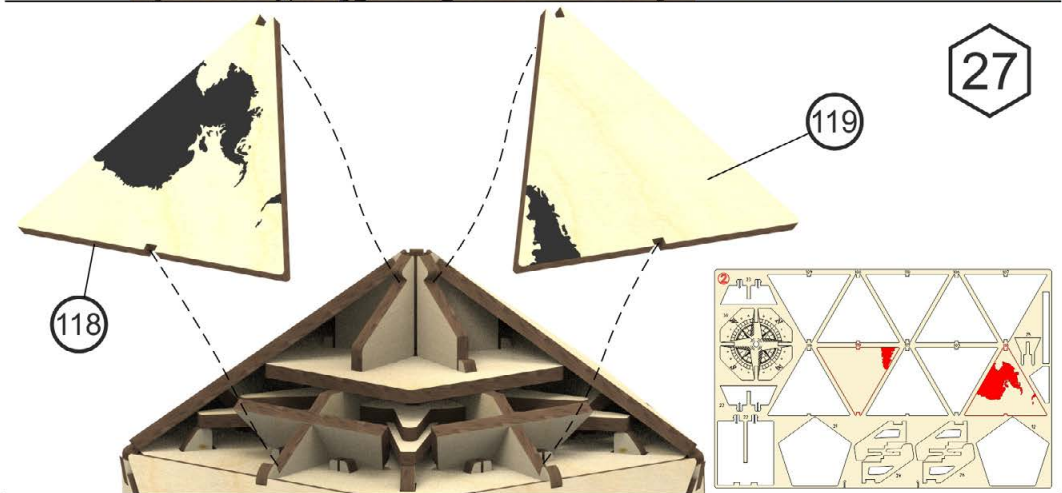
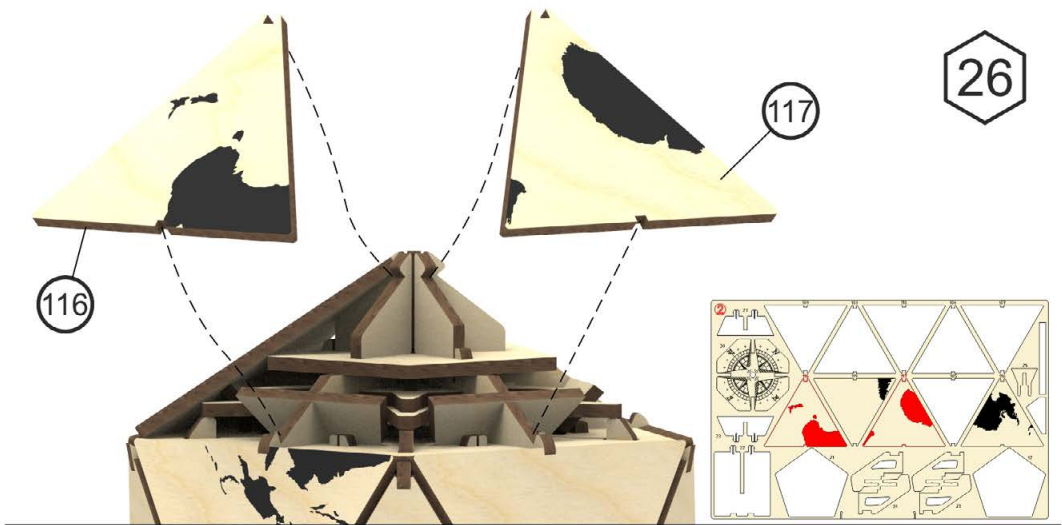



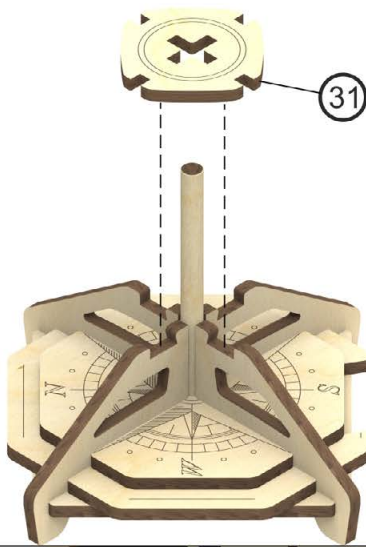

31

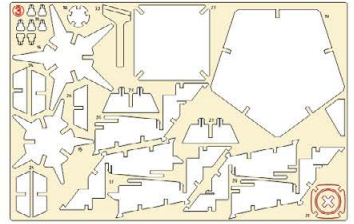

32

