

## ASSEMBLY INSTRUCTION

# RETRO TELEPHONE

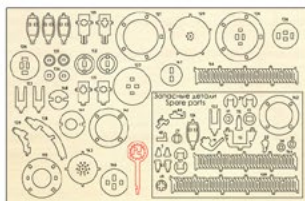



- EN** The ledge is for the squeezing the small details out of the board  
**PL** Wypstę w linijce przeznaczony jest do wyciskania małych detali z arkusza sklejk  
**FR** La proéminence est conçue pour aider à presser et enlever les petits détails de la feuille  
**ES** La repisa es para apretar los pequeños detalles fuera del tablero  
**DE** Der Vorsprung dient dazu, kleine Teile aus den Platten zu drücken  
**RU** Выступ предназначен для выдавливания из листа мелких деталей  
**IT** Le proiezioni riportate sui fogli di istruzione sono utili anche nella fase di smontaggio per estrarre i pezzi  
**CZ** Použitje k vytlačení malých částí z desky  
**CN** 輔助測量尺可幫助取出或緊接細小零件時使用



- EN** Rubber bands  
**PL** Gumki recepturki  
**FR** Des élastiques  
**ES** Gomas elásticas  
**DE** Gummibänder  
**RU** Резинки  
**IT** Elastici  
**CZ** Gumičky  
**CN** 橡橡皮筋



- EN** Cut it with a razor blade  
**PL** Odetnij nożem do kopert  
**FR** Couper avec un cutter  
**ES** Cortar con un bisturí  
**DE** Mit Rasierklinge durchschneiden  
**RU** Обрезать канцелярским ножом  
**IT** Tagliare con un celloso da cancelleria  
**CZ** Vyřízněte fezákem  
**CN** 用刀片切斷



- EN** Remove the burrs with sandpaper  
**PL** Usunąć zadziory papierem ściernym  
**FR** Retirer les bavures avec du papier à polir  
**ES** Quitar las rebabas con el papel esmeril  
**DE** Grate mit Schleifpapier entfernen  
**RU** Удалить заусенцы наждачной бумагой  
**IT** Sbavare con carta vetrata  
**CZ** Vyhladte smirkových papírem  
**CN** 用砂紙去除毛刺。



- EN** Details should rotate freely  
**PL** Swobodne obracanie  
**FR** Libre rotation  
**ES** Rotación libre  
**DE** Auf freie Rotation achten  
**RU** Свободное вращение  
**IT** Rotazione libera  
**CZ** Části by se měly volně otáčet  
**CN** 流畅地旋转



- EN** Wax it with a candle  
**PL** Posmaruj za pomocą świecy parafinowej  
**FR** Graisser avec une bougie de paraffine  
**ES** Engrasar con ayuda de una vela de parafina  
**DE** Mit einer Kerze wachsen  
**RU** Смазать парафиновой свечой  
**IT** Lubrificare con candela di paraffina  
**CZ** Navoskujte svíčkou  
**CN** 用干蜡烛上蜡润滑



- EN** Pay attention  
**PL** Uwaga  
**FR** Prêtez attention  
**ES** Prestar atención  
**DE** Achtung  
**RU** Уделить внимание  
**IT** Prestare attenzione  
**CZ** Pozor  
**CN** 请注意

**EN** The manufacturer reserves the right to make changes in the design of the product, not worsening its technical characteristics. Information about the changes made may not be present in this manual.

**PL** Producent zastrzega sobie prawo do zmiany konstrukcji wyrobu bez pogorszenia jego właściwości technicznych. Niniejsza instrukcja może nie zawierać informacji o zmianach.

**FR** Le producteur se réserve le droit d'apporter des modifications dans la construction du produit à condition si elles ne portent atteinte à ses caractéristiques techniques. Les renseignements sur les modifications apportées peuvent ne pas être dans la présente notice.

**ES** El fabricante se reserva el derecho de introducir modificaciones en la construcción del producto, que no empeoran sus características técnicas. Datos sobre modificaciones introducidas pueden no aparecer en esta instrucción.

**DE** Der Hersteller behält sich das Recht auf Designänderungen, die die technischen Merkmale und Funktionen nicht negativ beeinflussen, vor.

**RU** Производитель оставляет за собой право вносить изменения в конструкцию изделия, не ухудшающие его технические характеристики. Сведения о внесенных изменениях могут отсутствовать в настоящей инструкции.

**IT** Il produttore si riserva il diritto di apportare modifiche al design del prodotto, non peggiorando le sue caratteristiche tecniche. Informazioni sulle modifiche apportate potrebbero non essere presenti in questo manuale.

**CZ** Výrobce si vyhrazuje právo na takové změny v designu produktu, které nebudou mít za následek zhoršení technických vlastností. Informace o změnách nemusí být v návodu uvedeny.

**CN** 制造商保留对产品的设计更改的权利，一切改良旨在增强产品的技术性能。改良处若未出现在手册中，敬请谅解

1

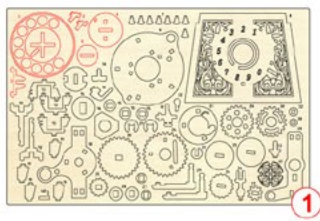
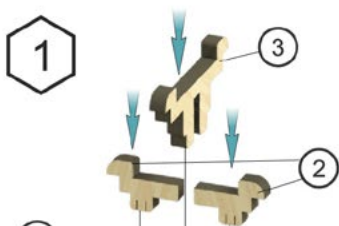

2

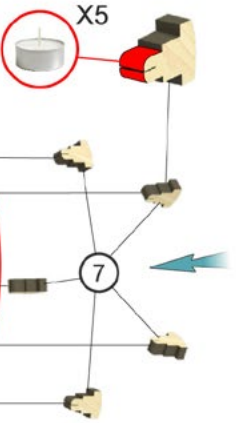
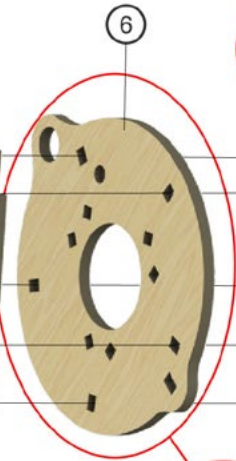
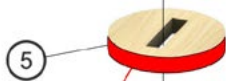
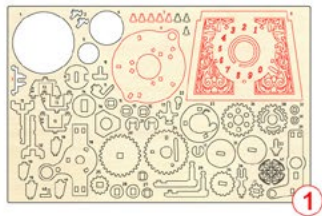

3

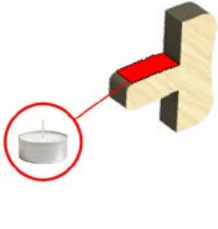
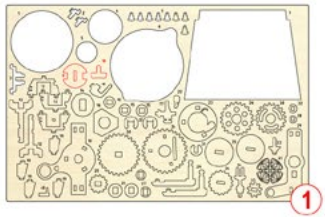
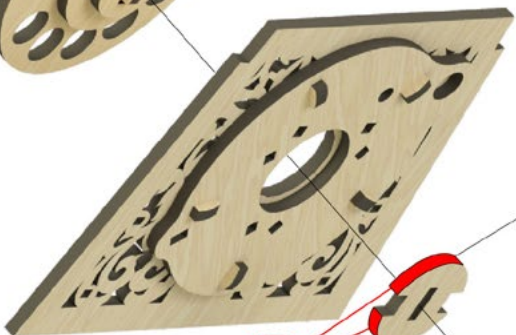
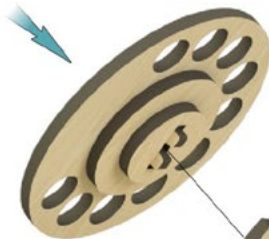

4

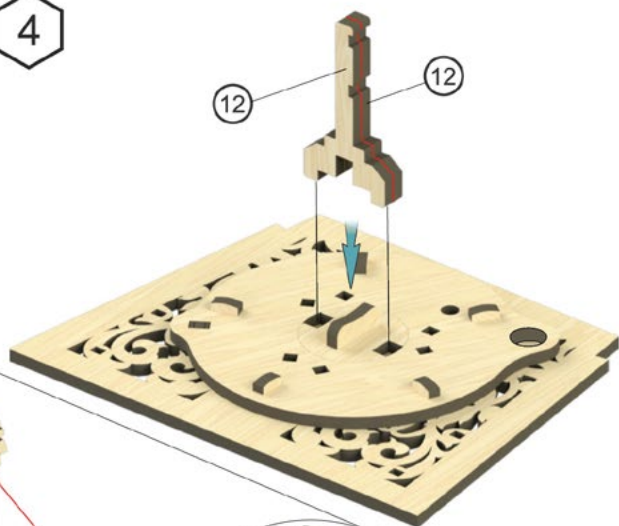
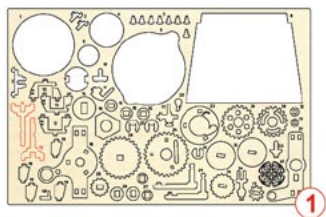

5

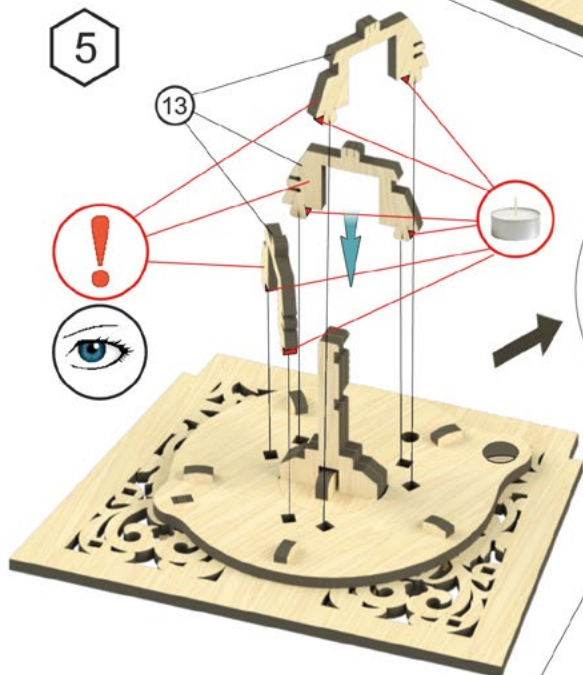

6

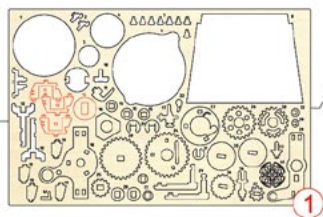
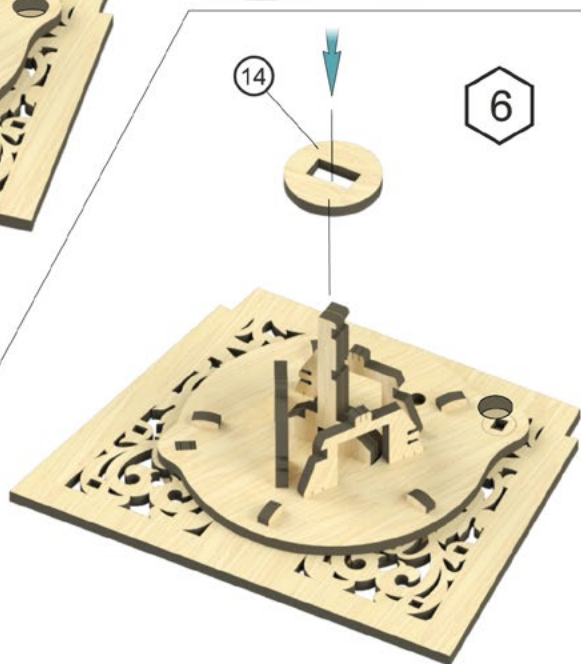

7

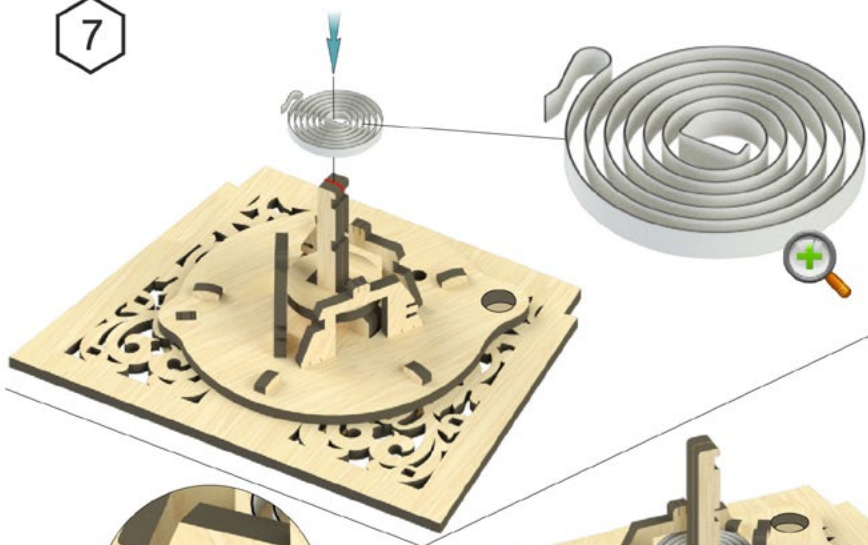

8

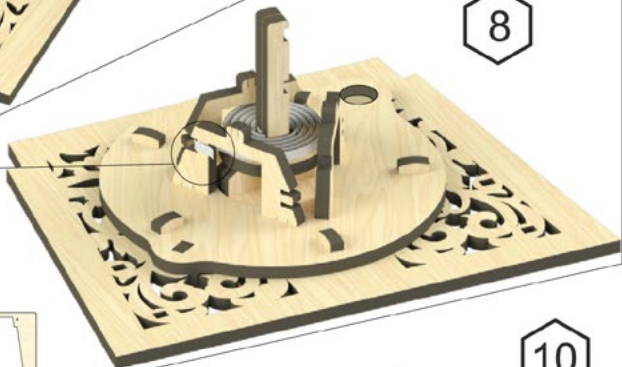
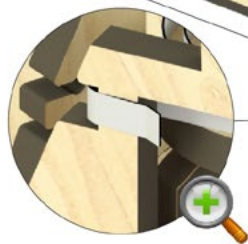

9

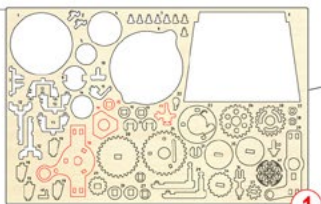

1

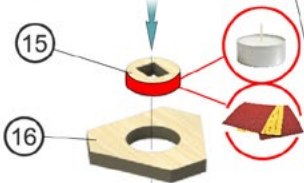

10

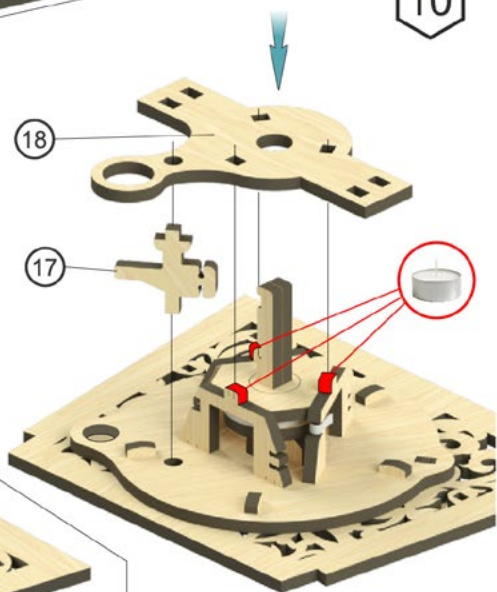

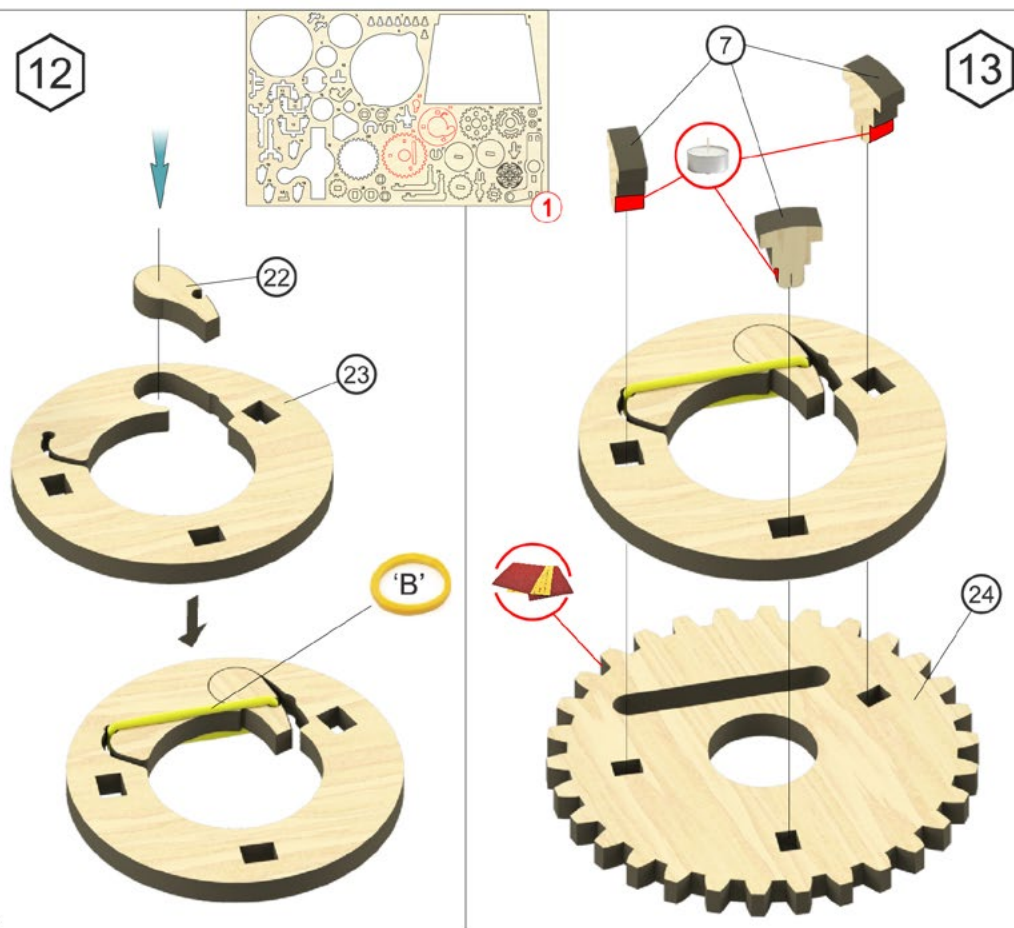
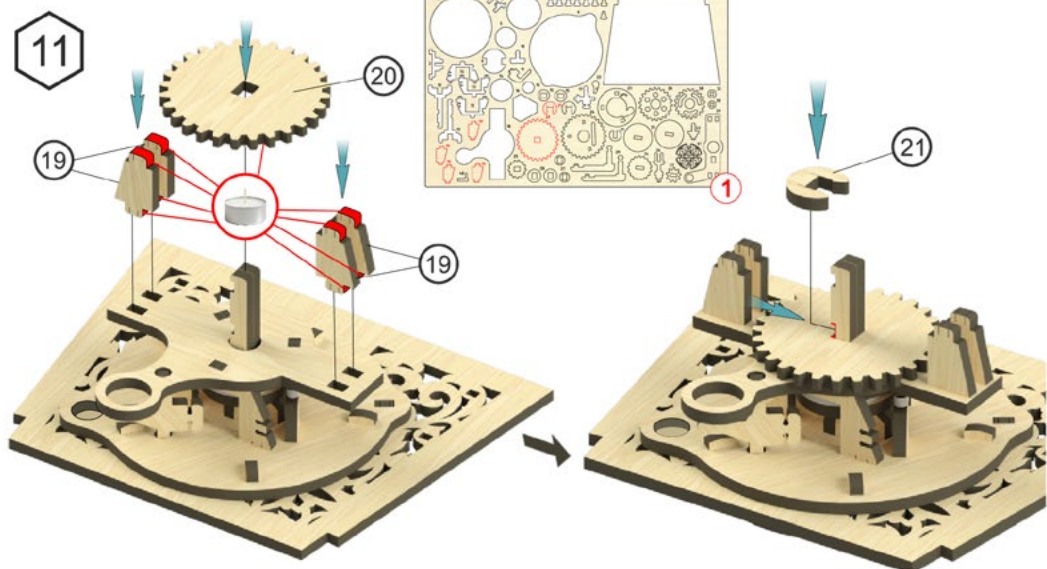

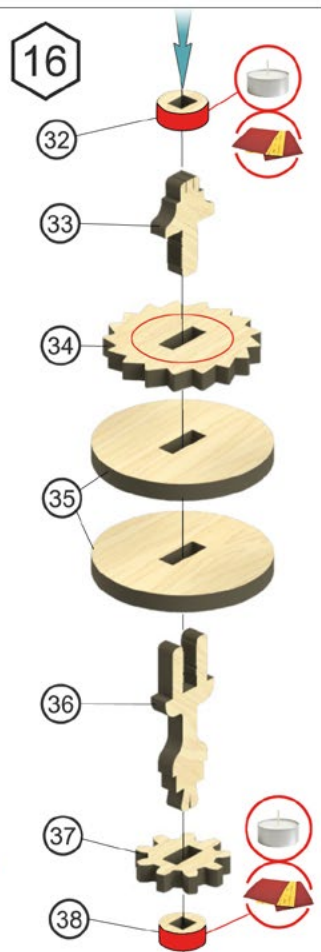
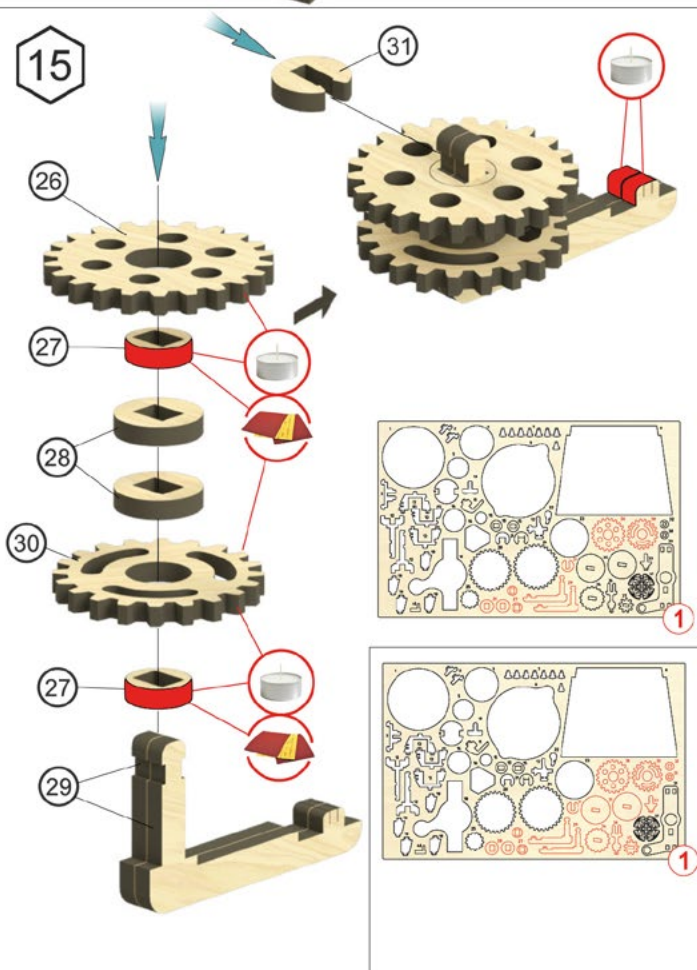
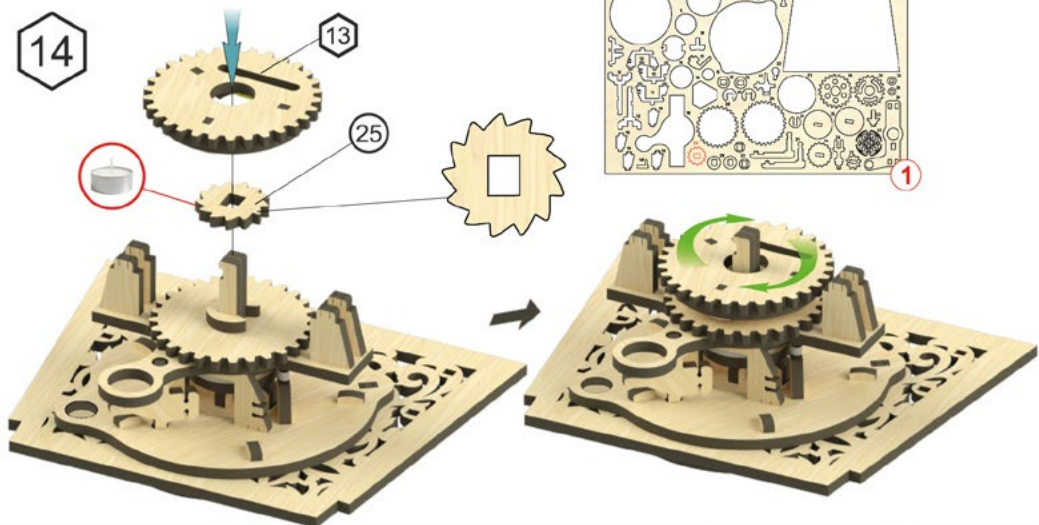

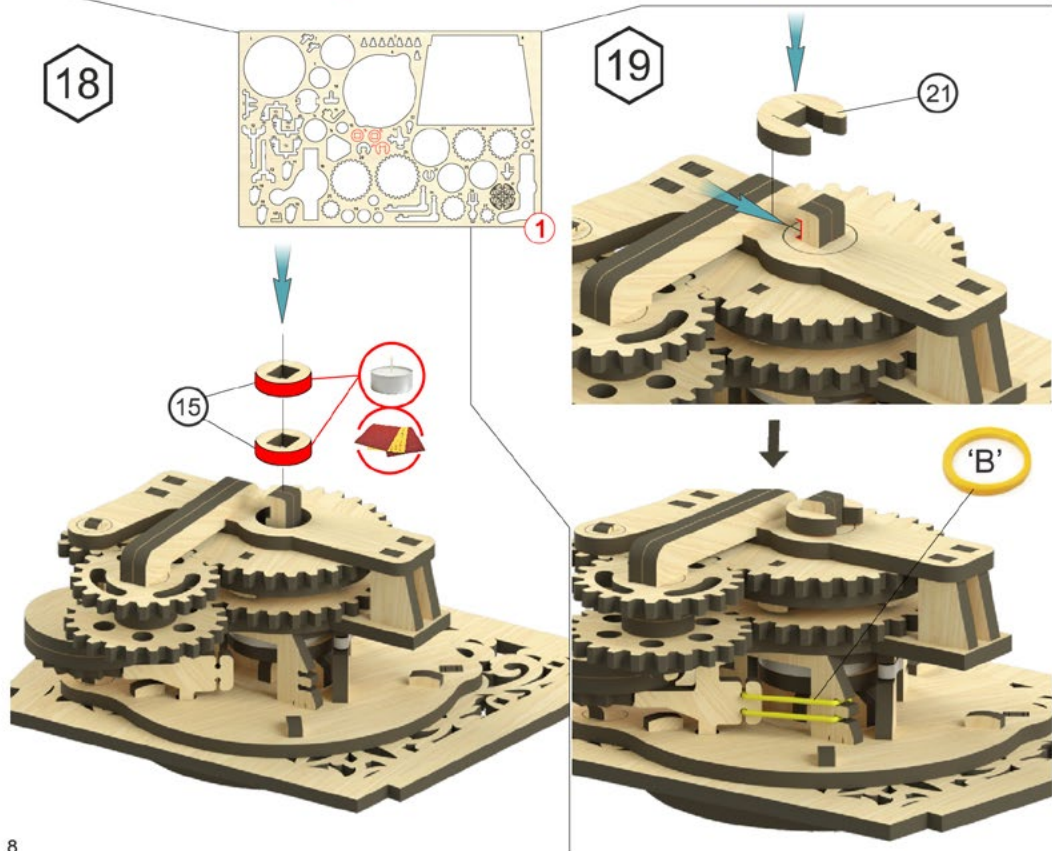
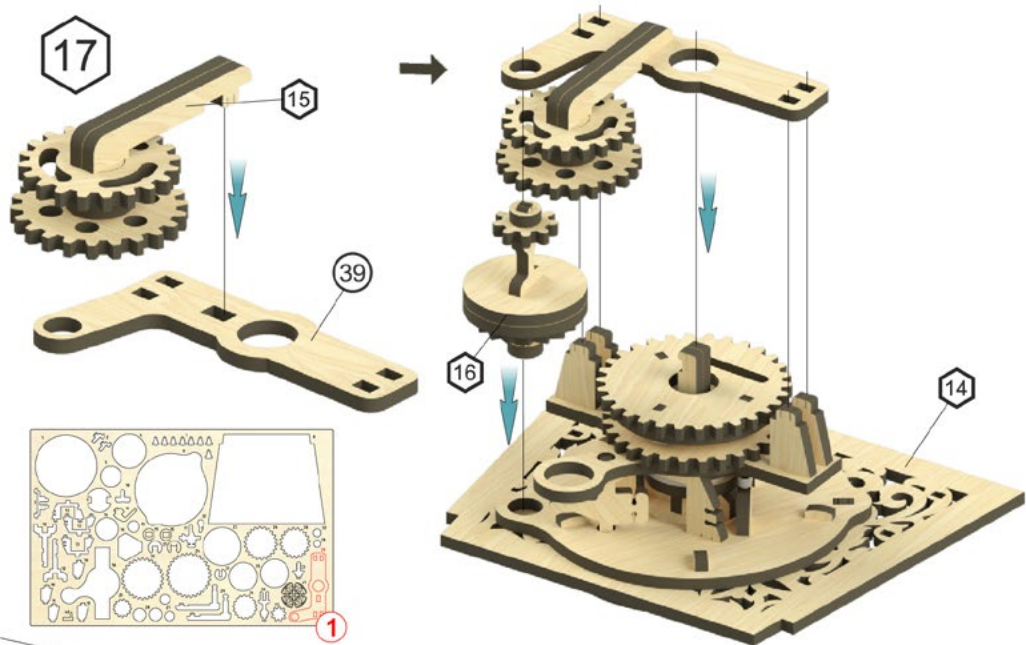

20

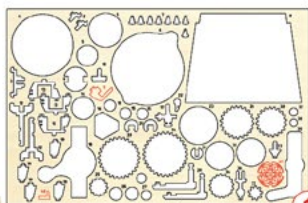
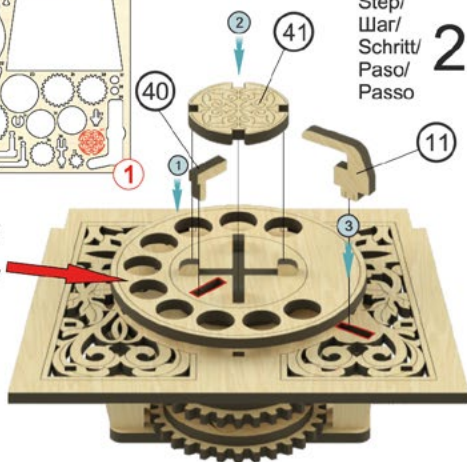
Step/  
Шаг/  
Schritt/  
Paso/  
Passo 1Step/  
Шаг/  
Schritt/  
Paso/  
Passo 2Fix/  
Держать/  
Fix/  
Sostener/  
Presa

21

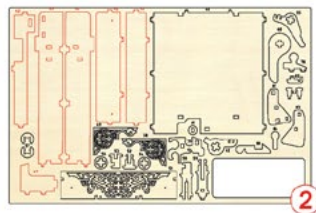
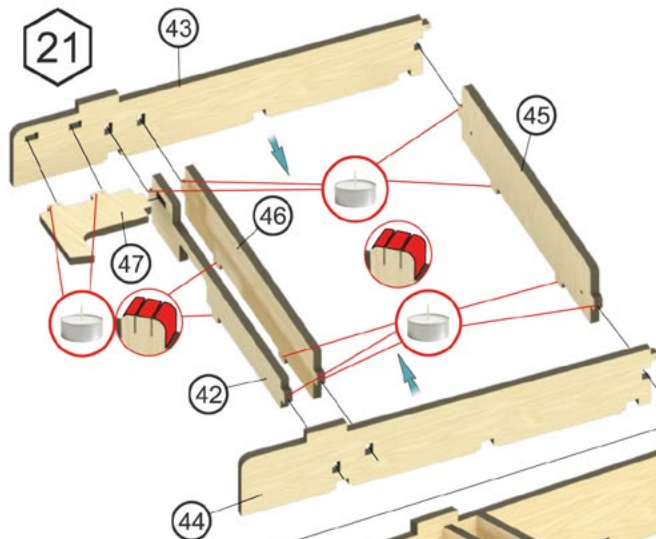

22

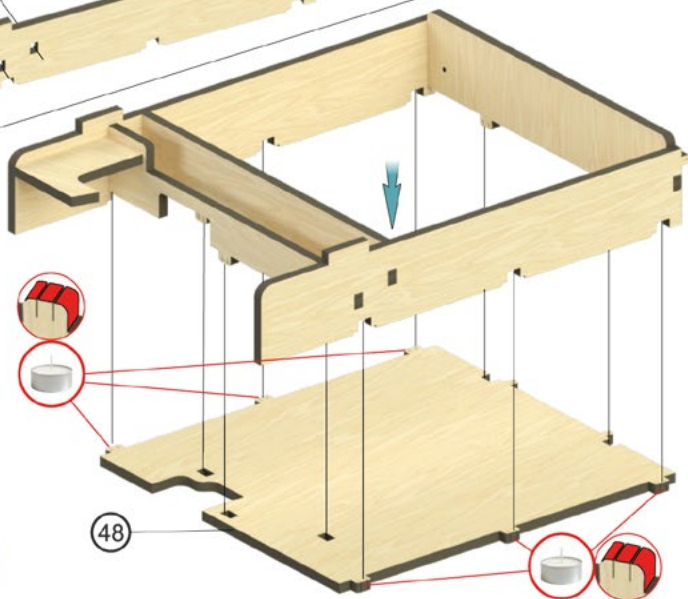
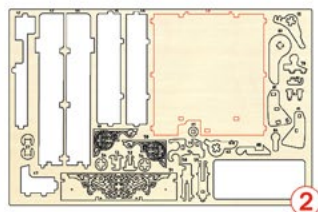

23

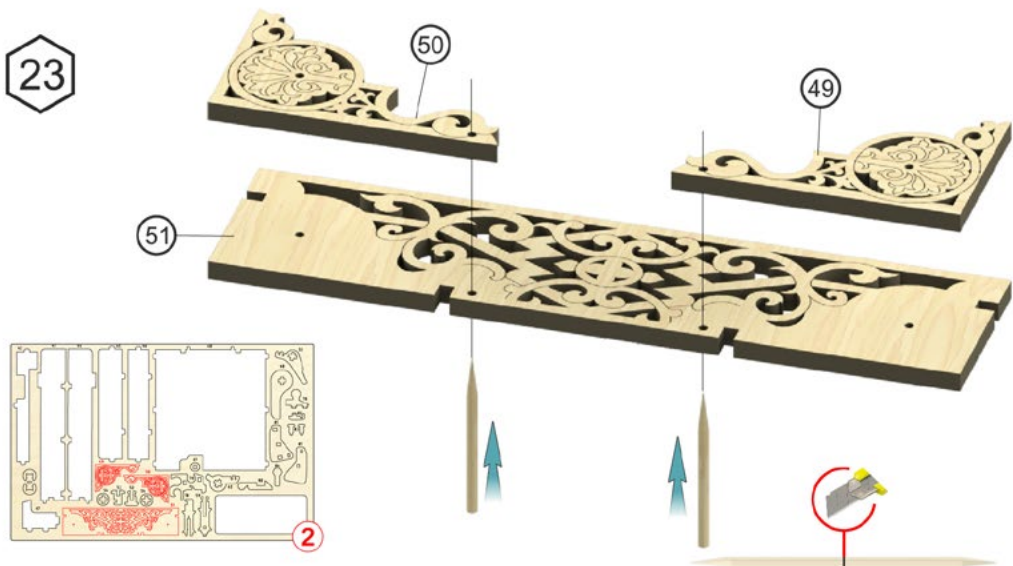

24

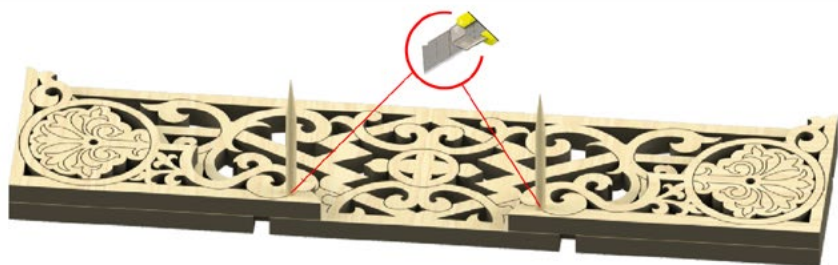

25

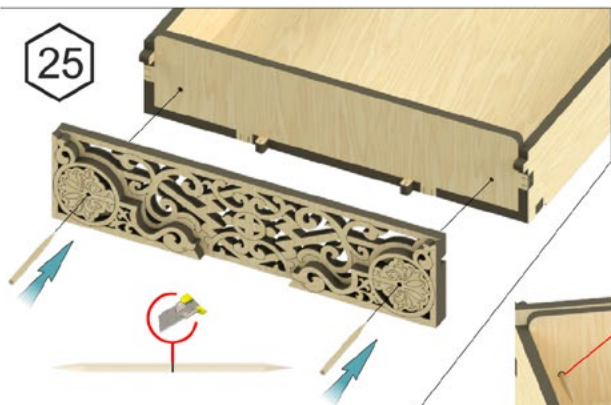

26



27

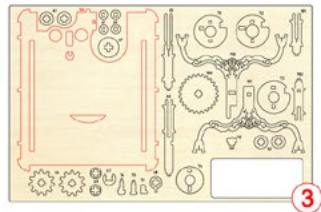
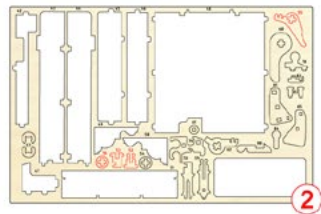
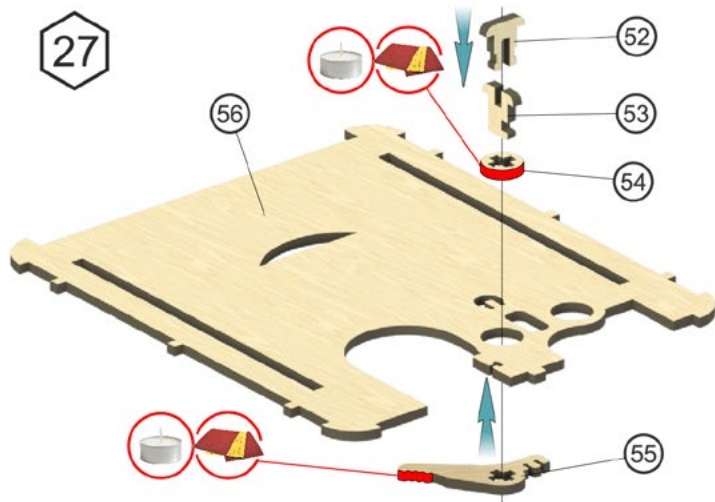

28

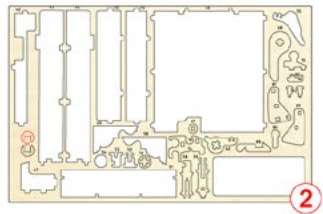

29

'B'

Step/  
Шаг/  
Schritt/  
Paso/  
Passo

1



Step/  
Шаг/  
Schritt/  
Paso/  
Passo

2



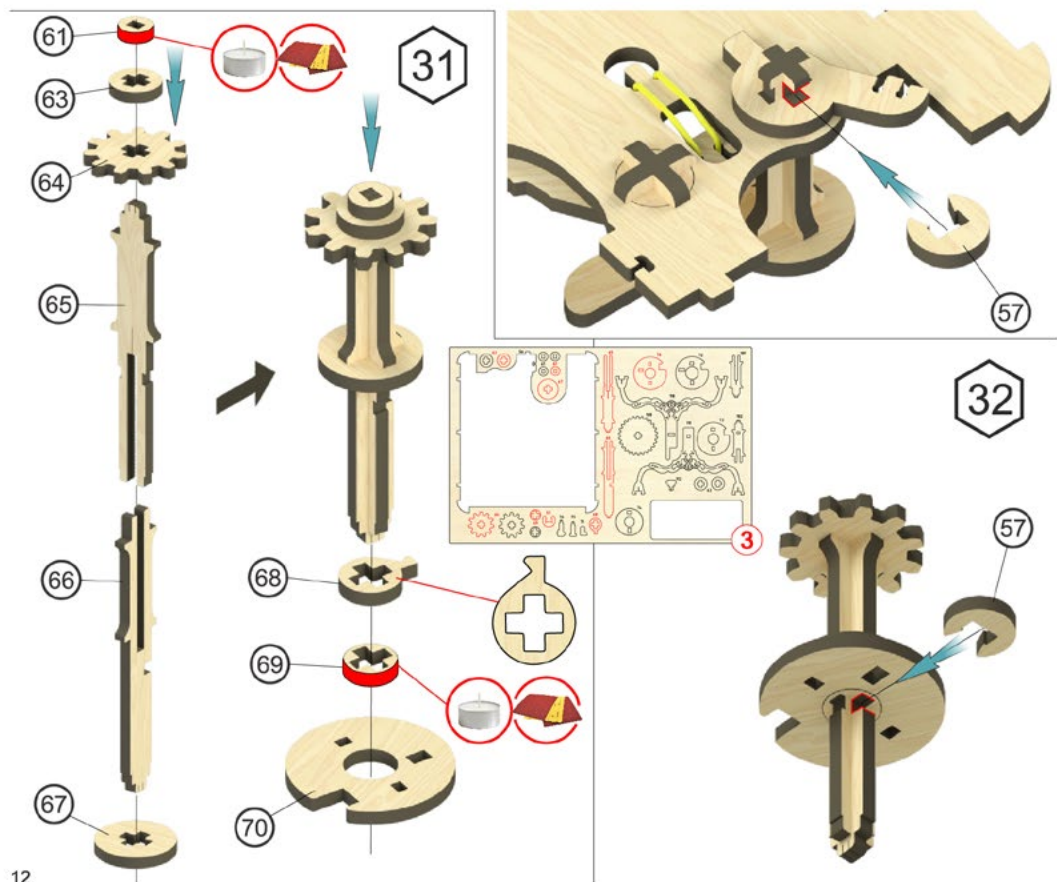
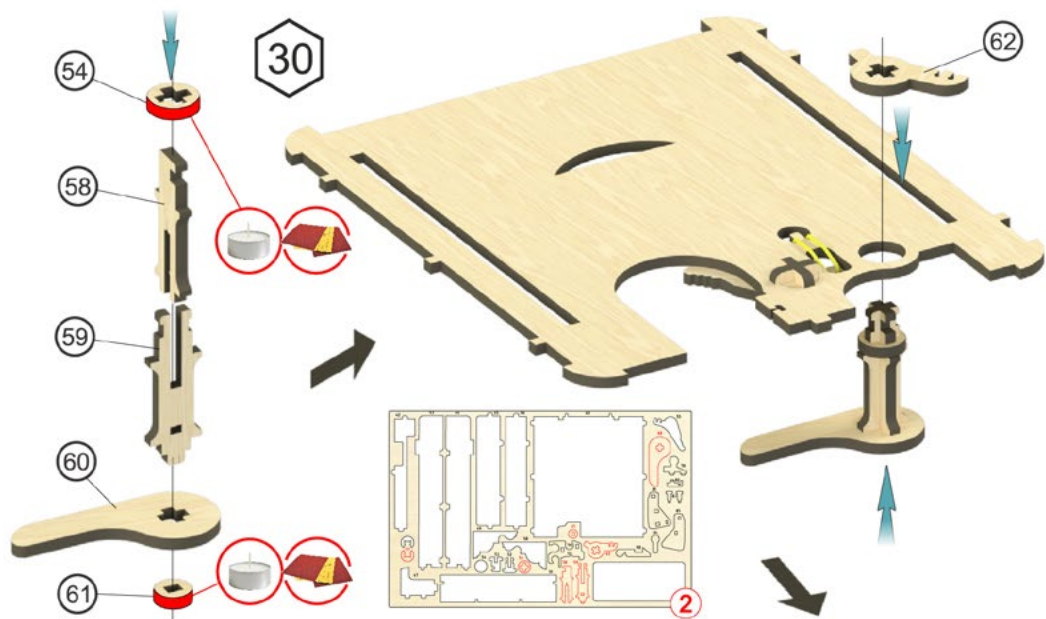

33

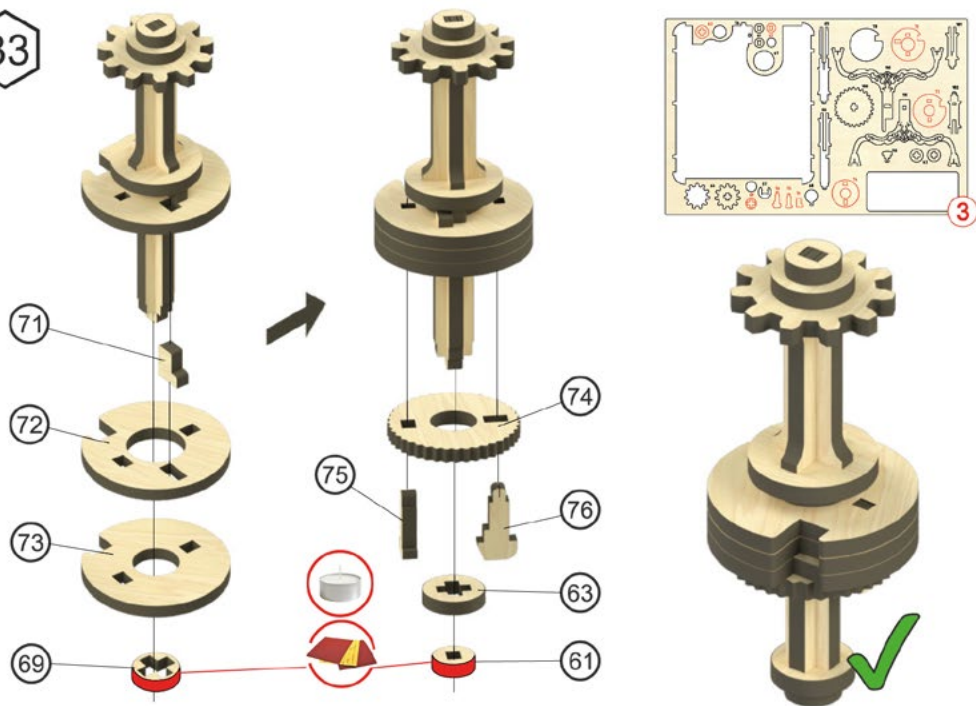

34

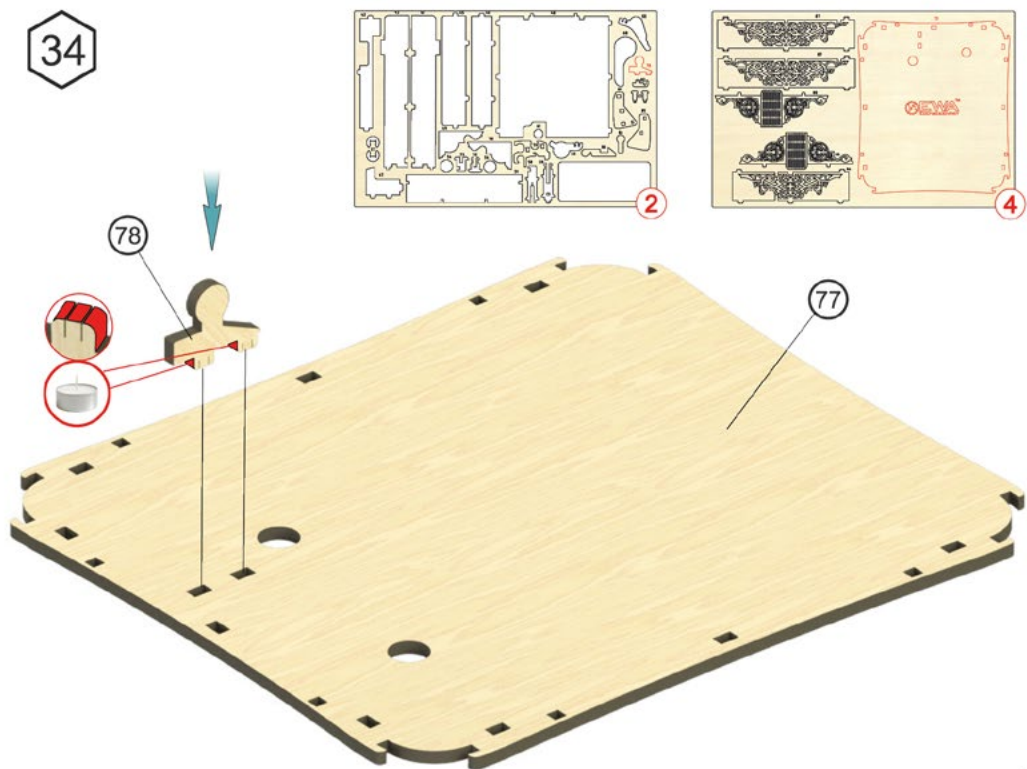

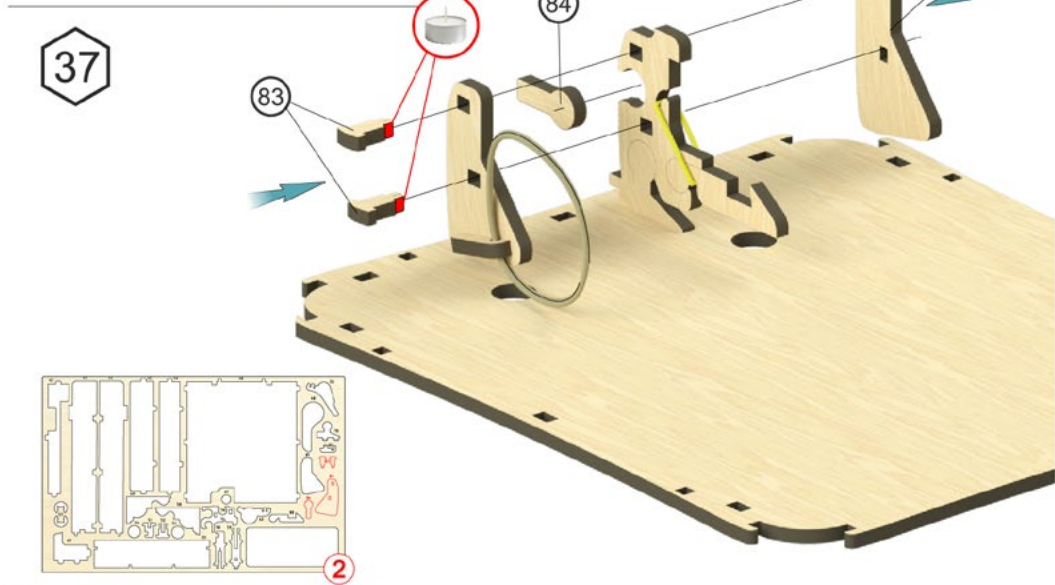
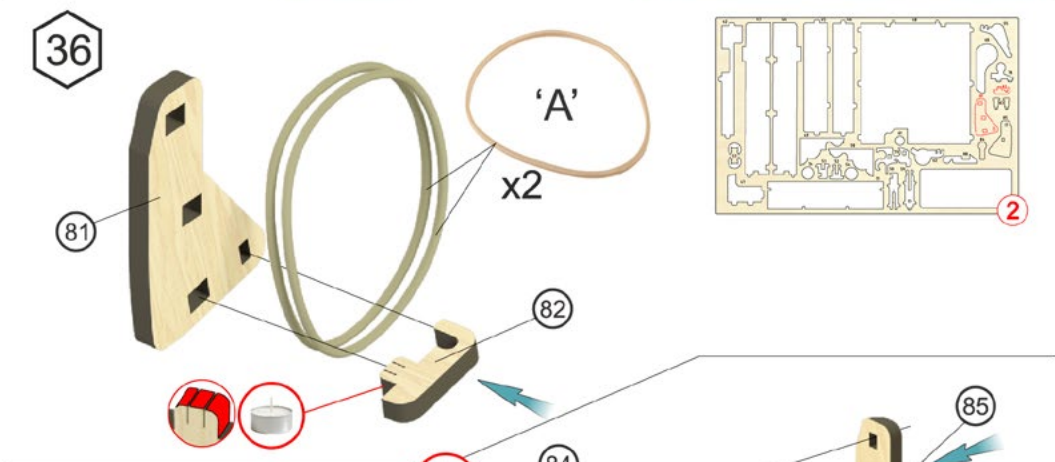
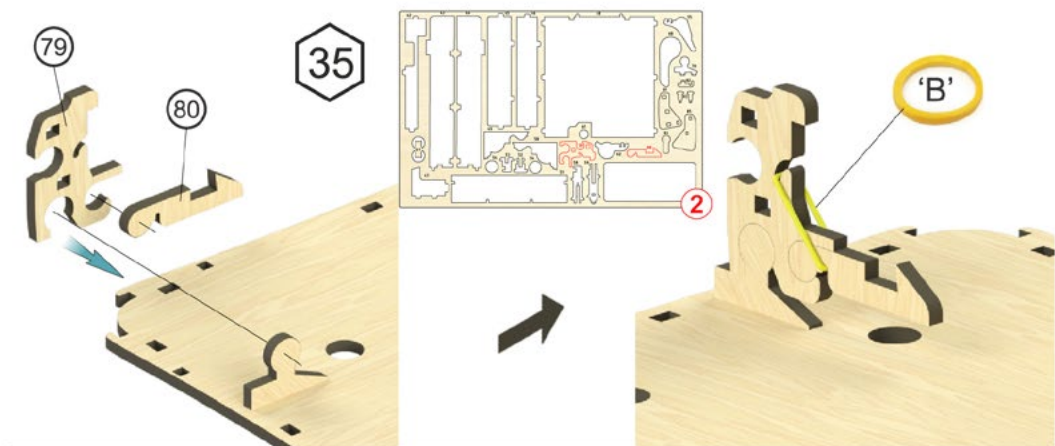

38

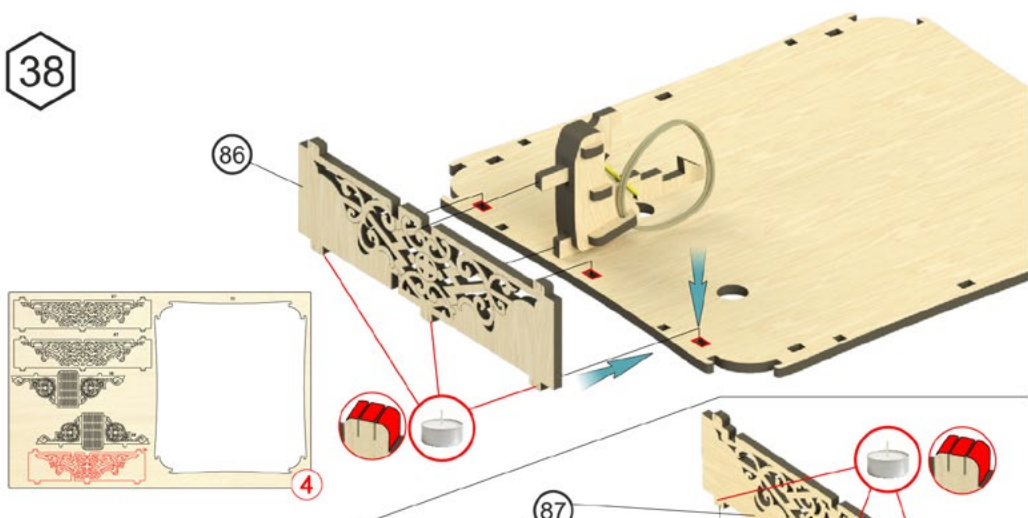

39

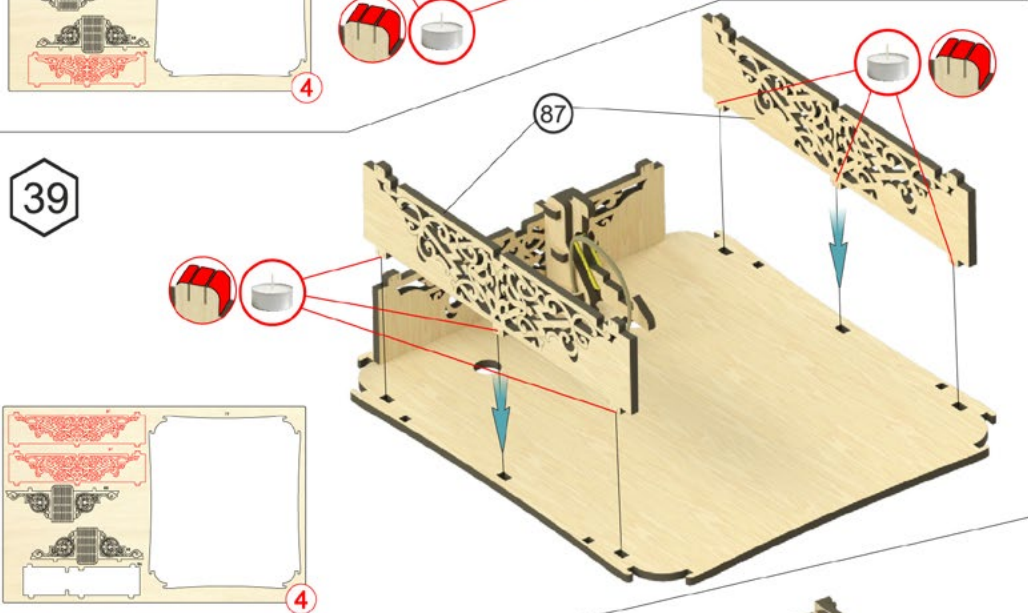

40

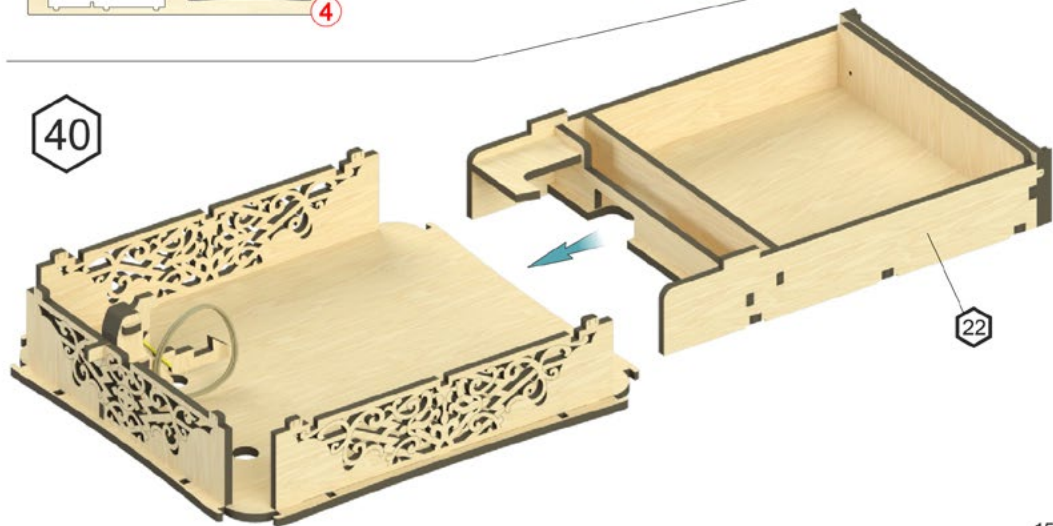

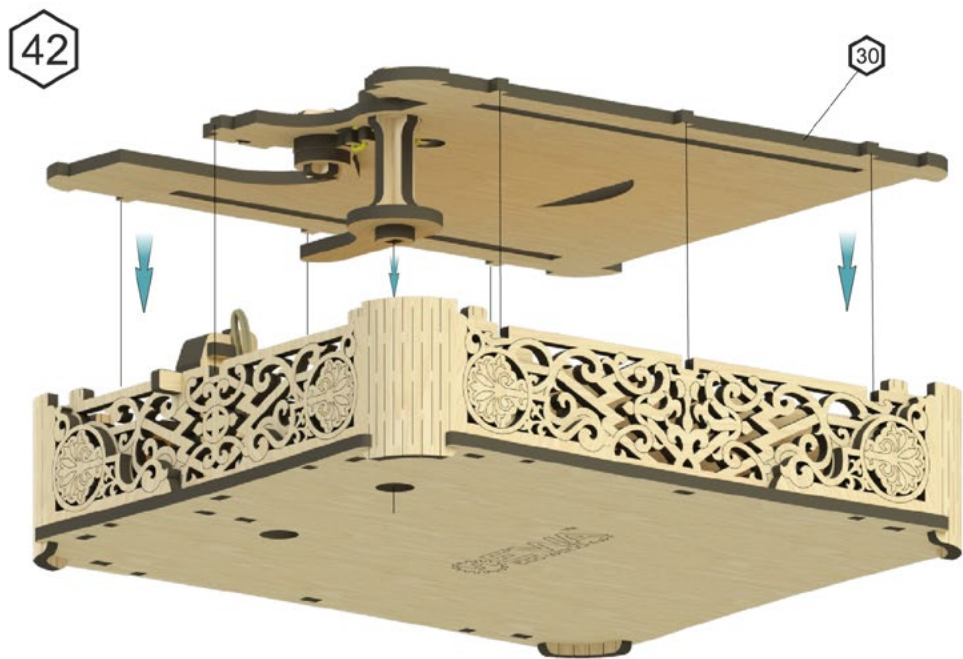
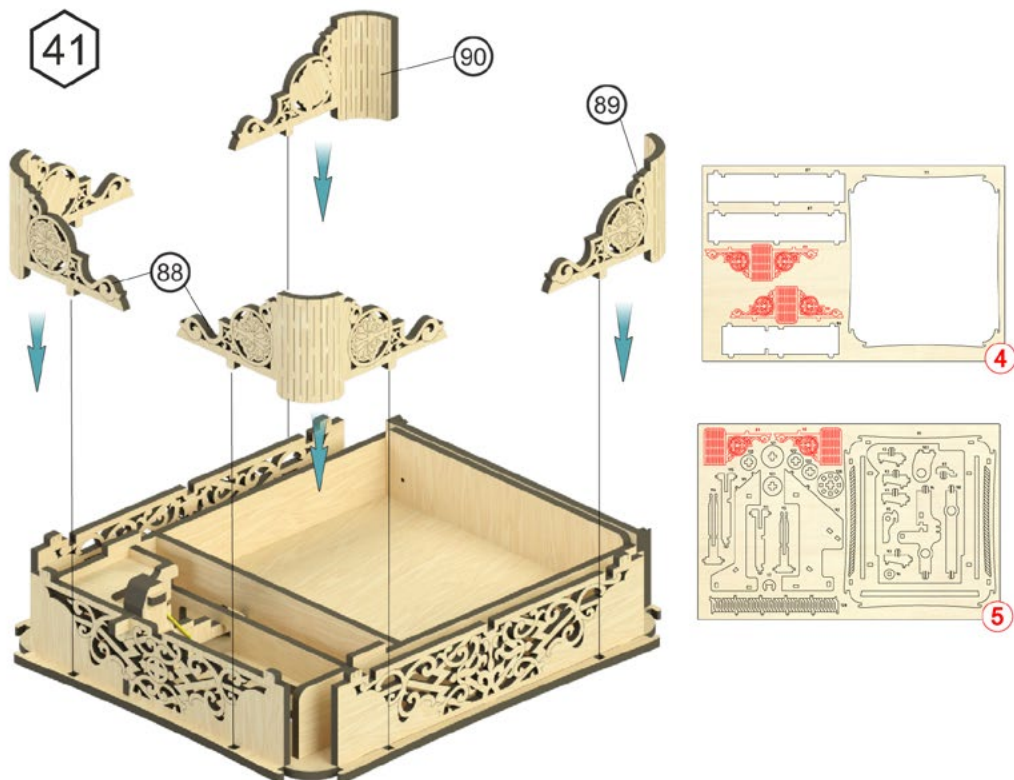

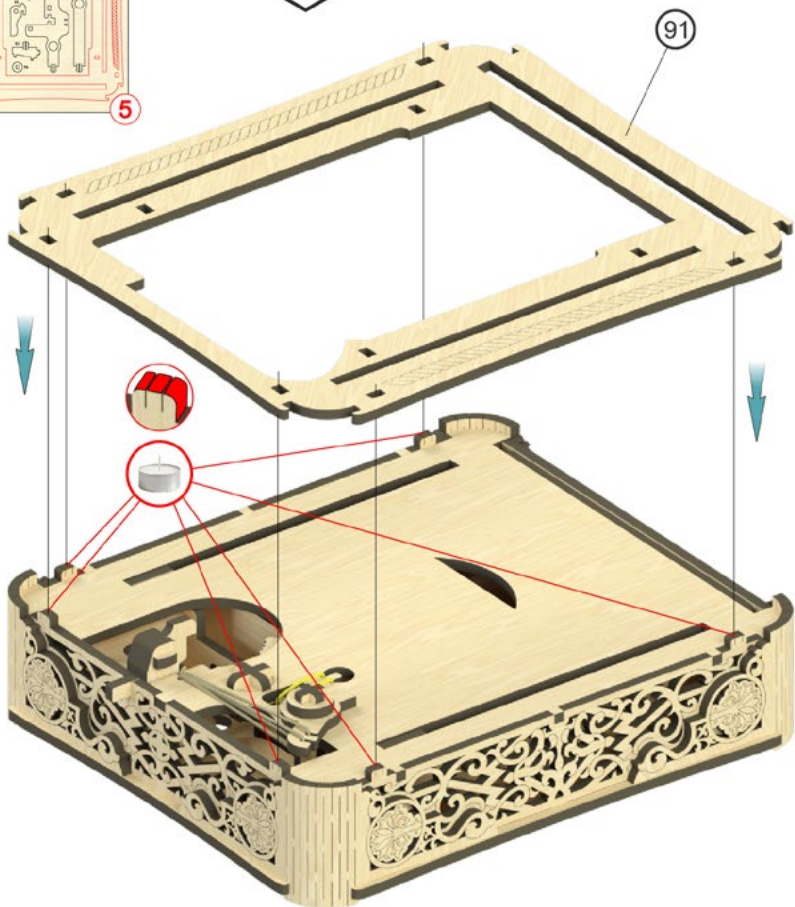
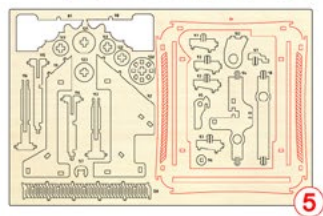
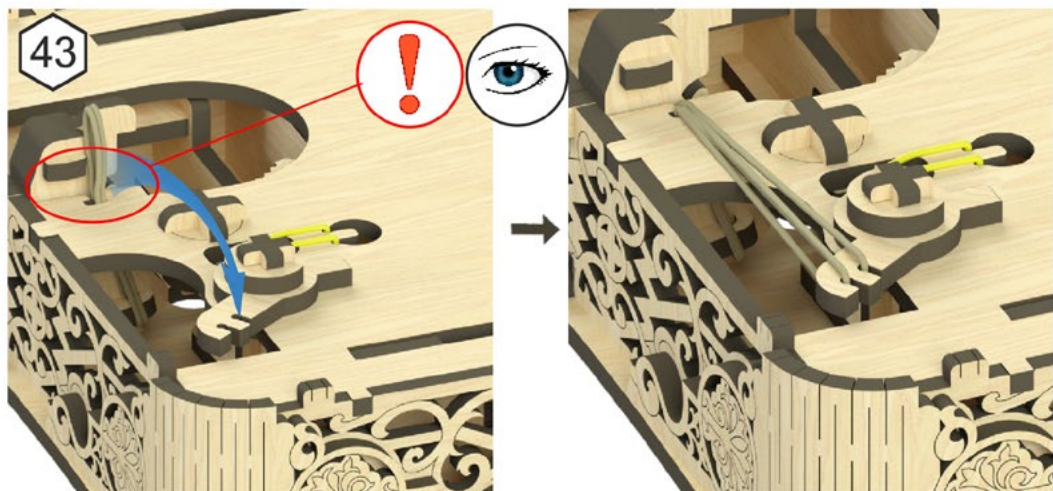

45

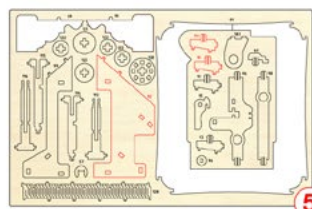
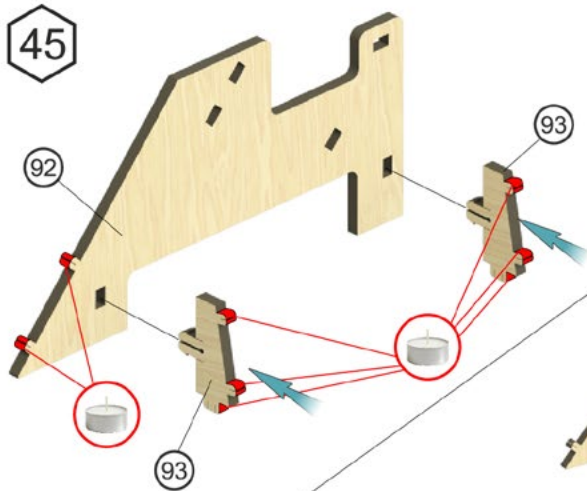

46

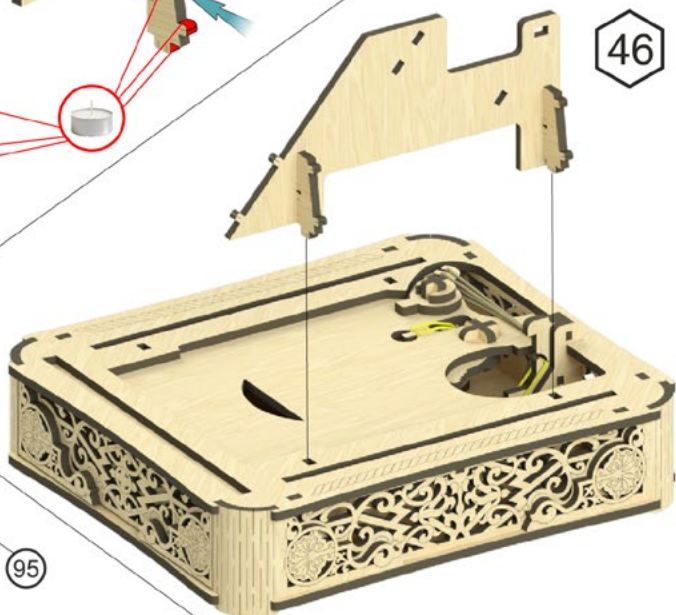

47

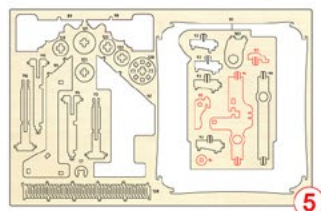
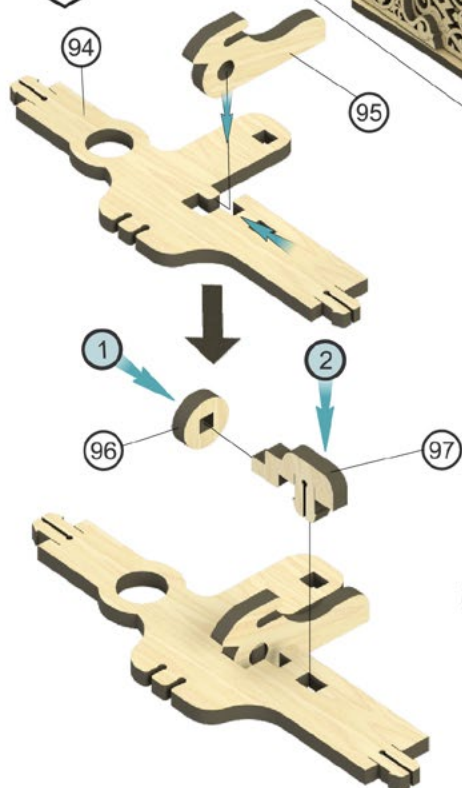

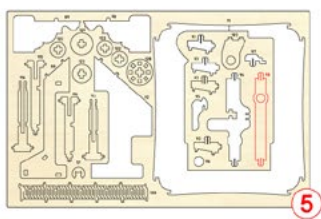
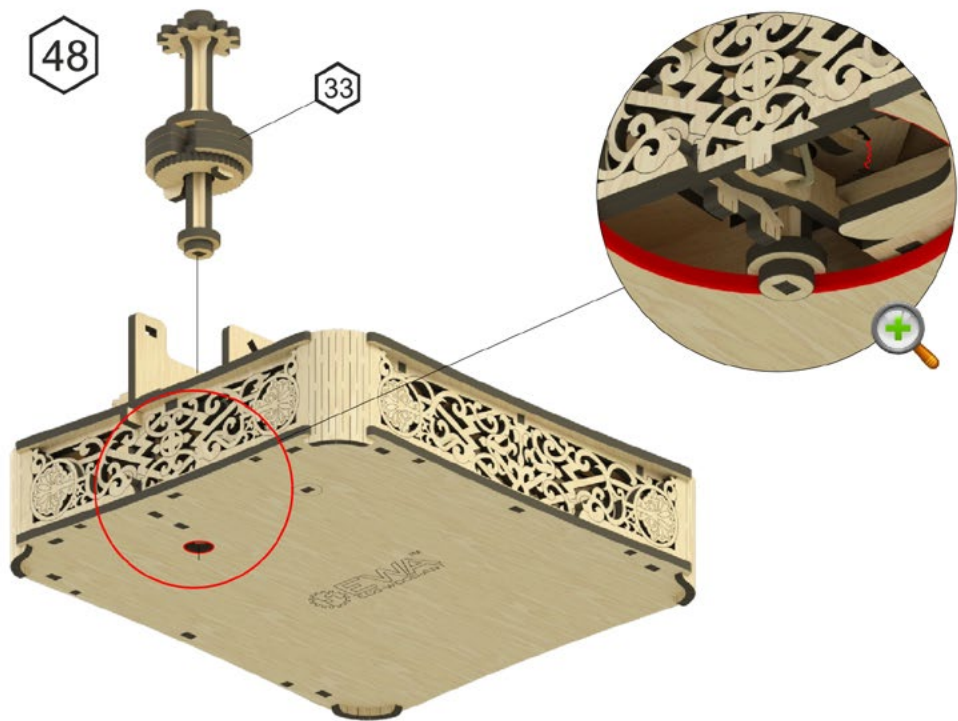

49

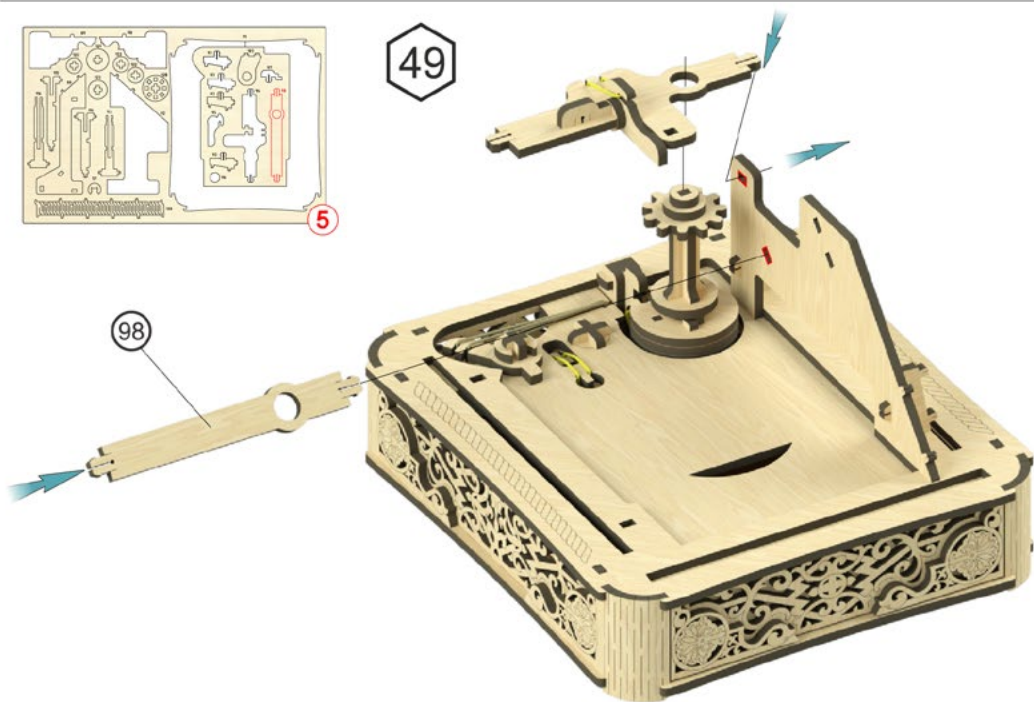

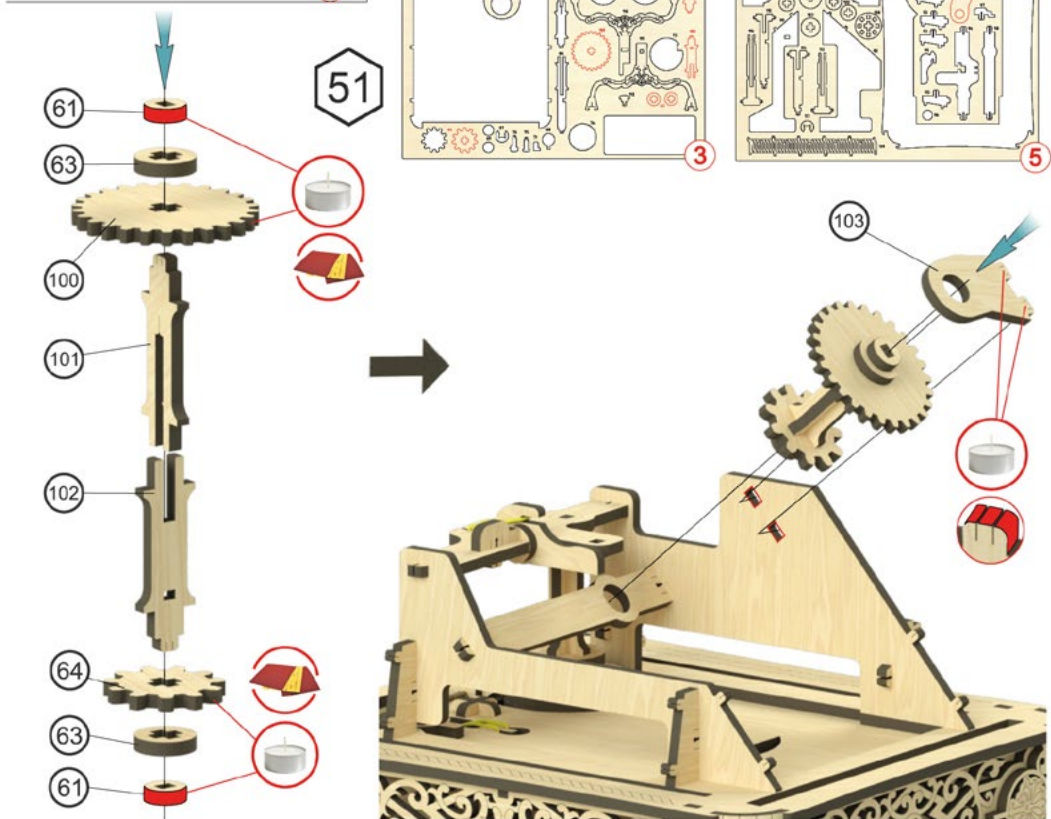
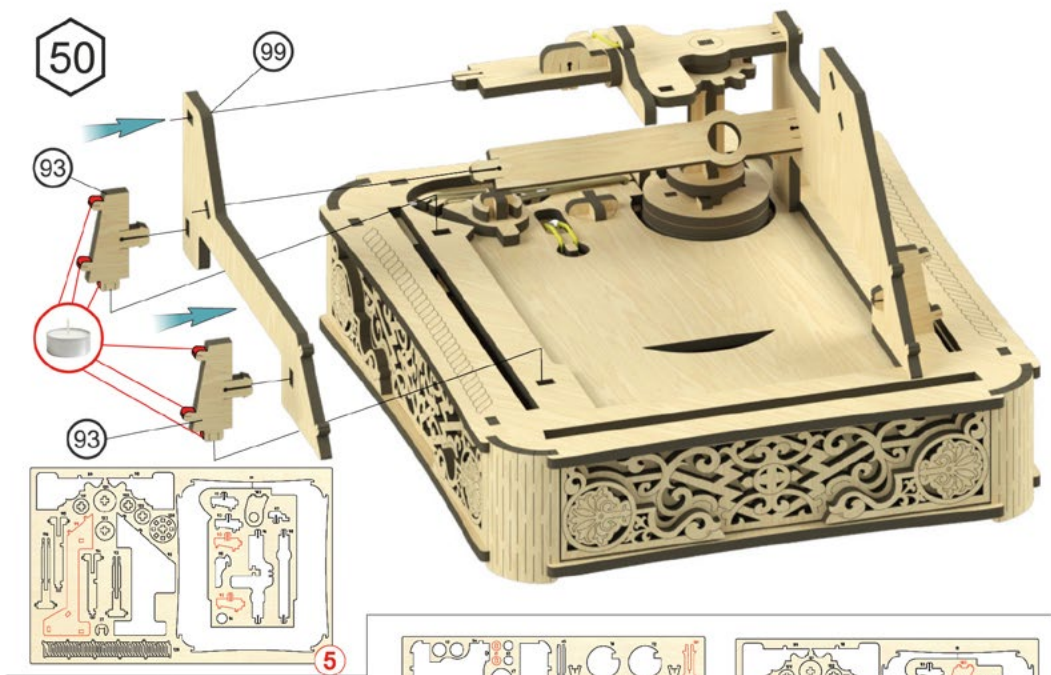

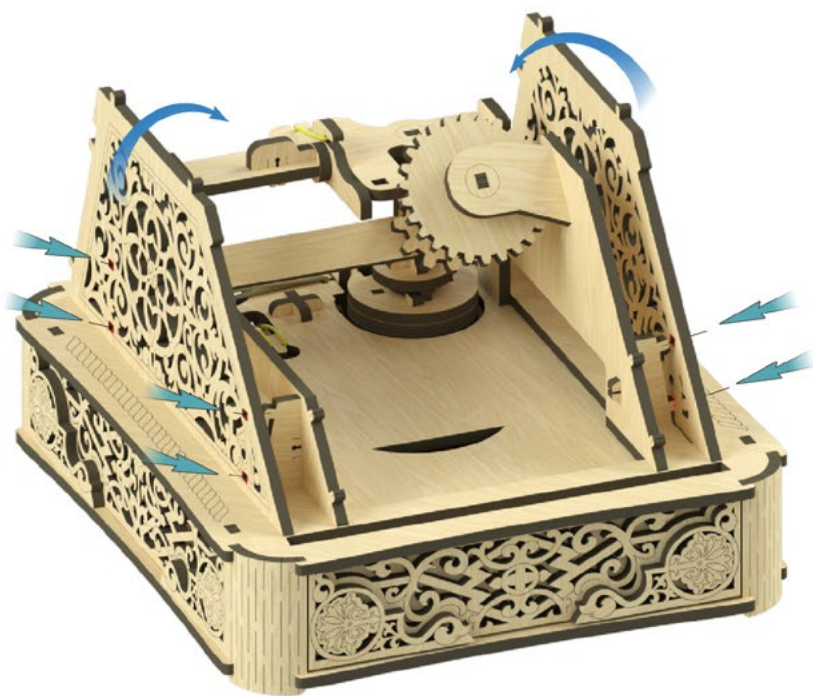
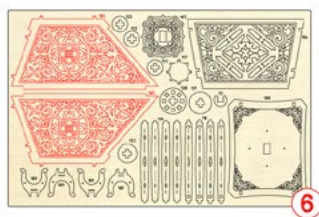
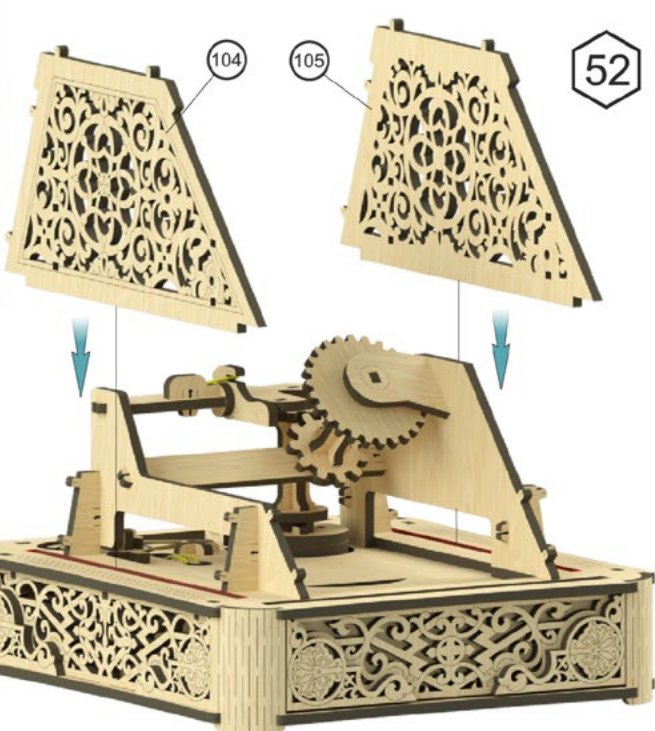

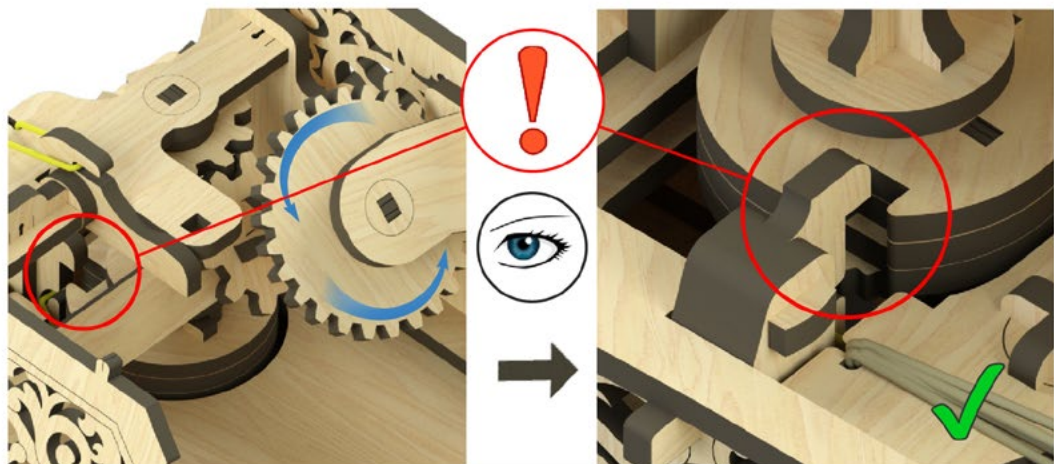

53

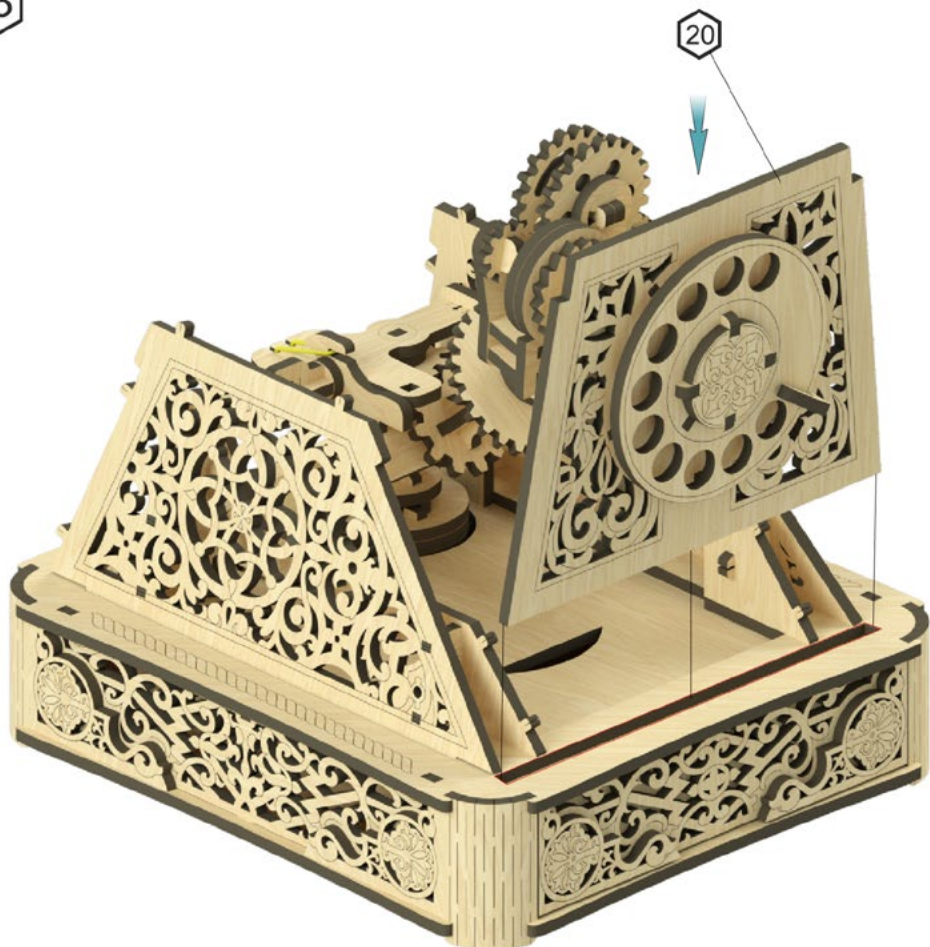

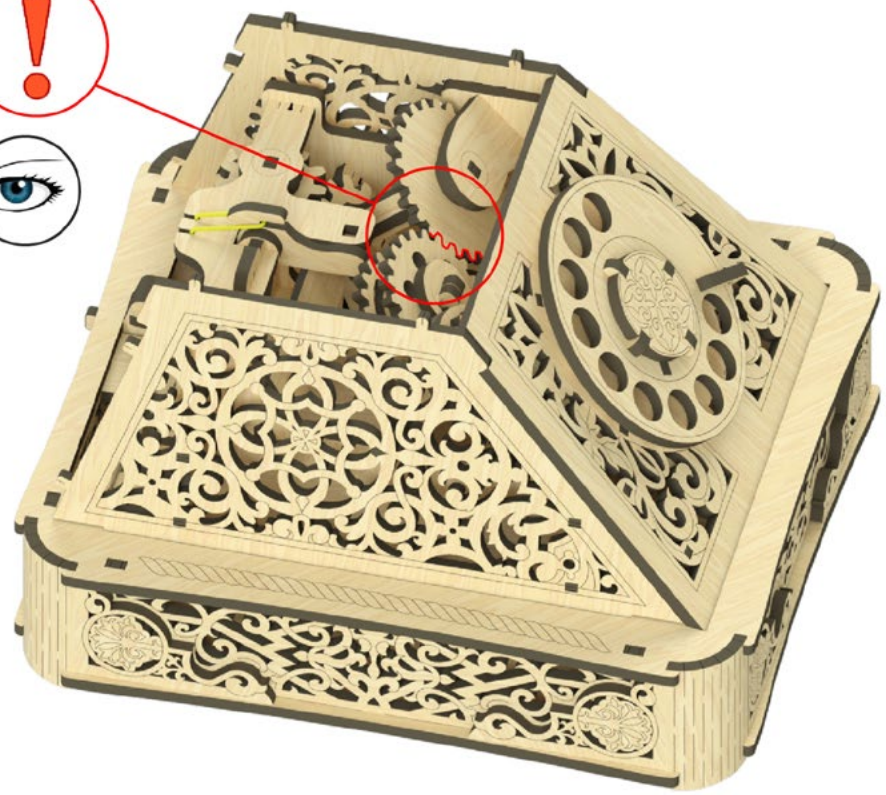
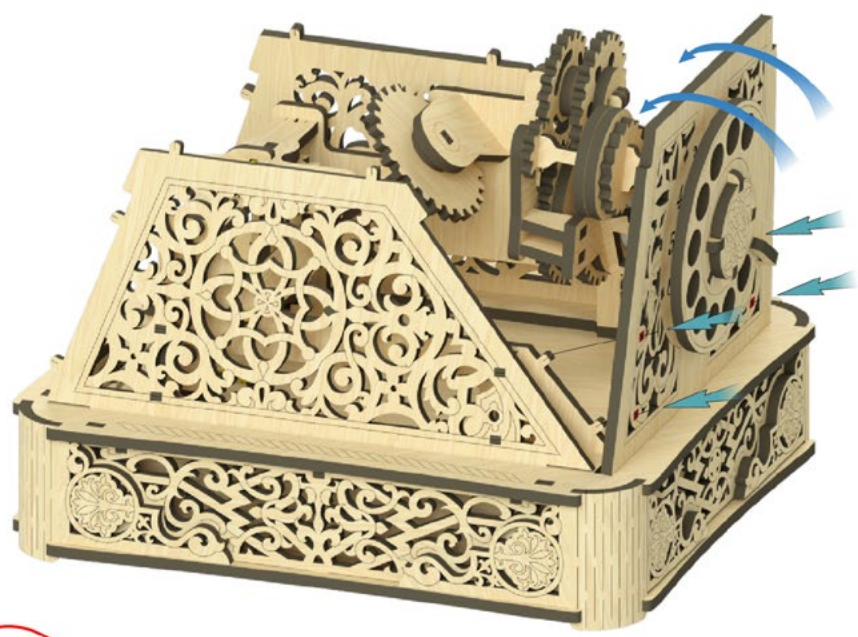

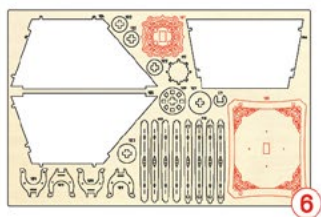
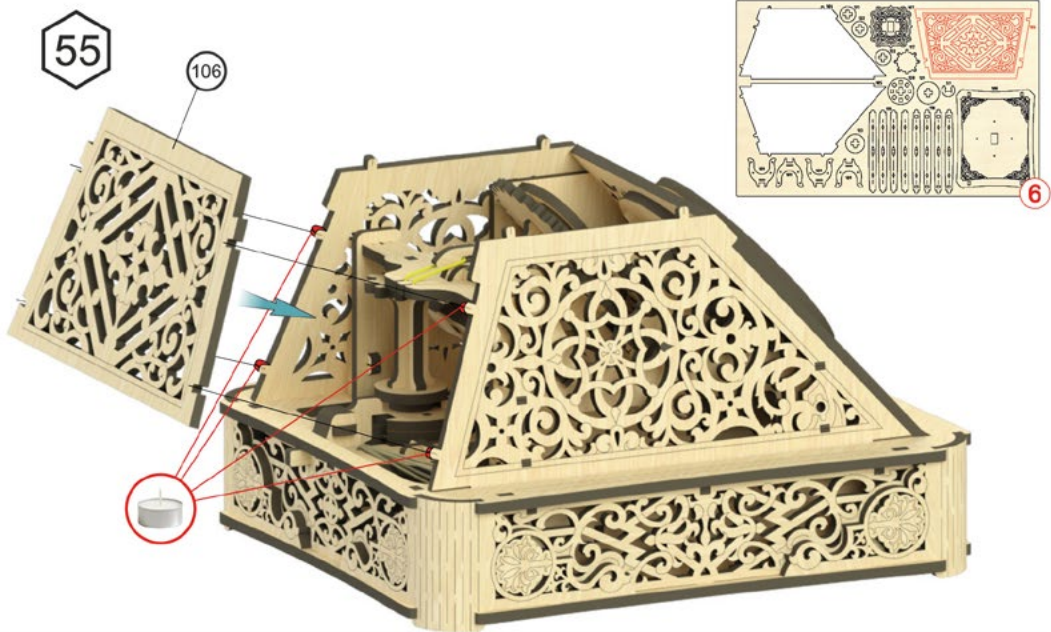

56

107

108

x2

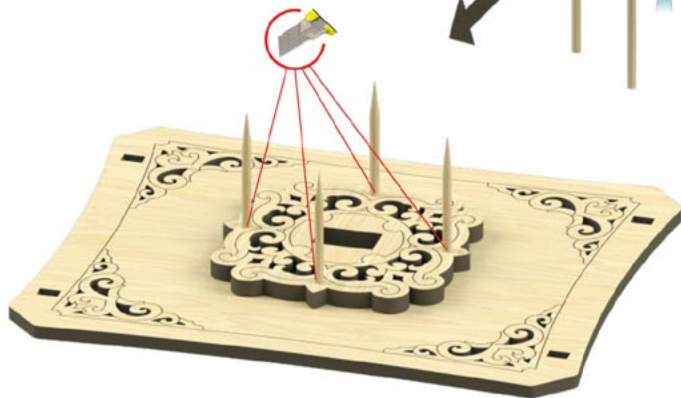

57

x2

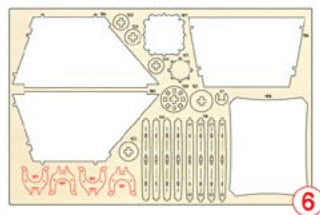
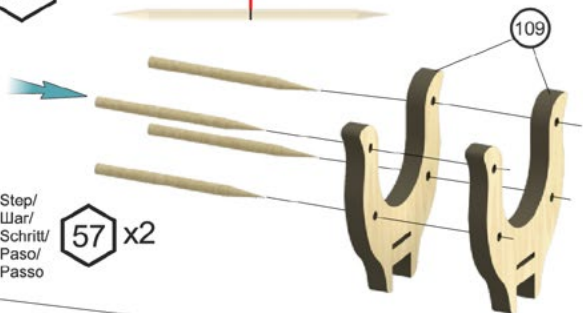

6

Step/  
Wär/  
Schritt/  
Paso/  
Passo

57 x2

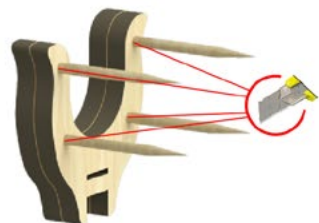

58

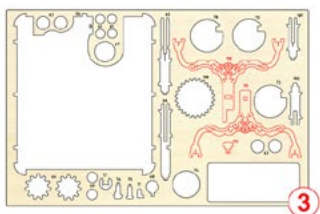
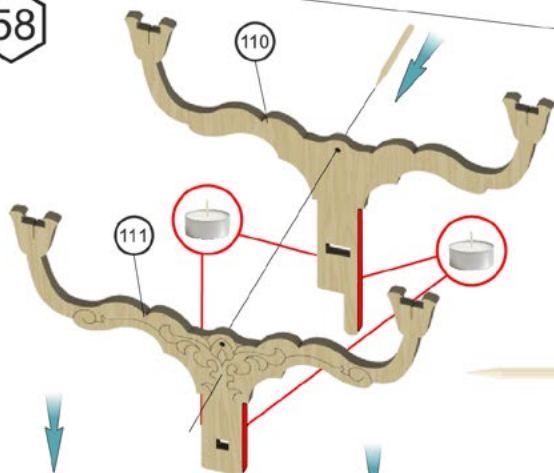

3

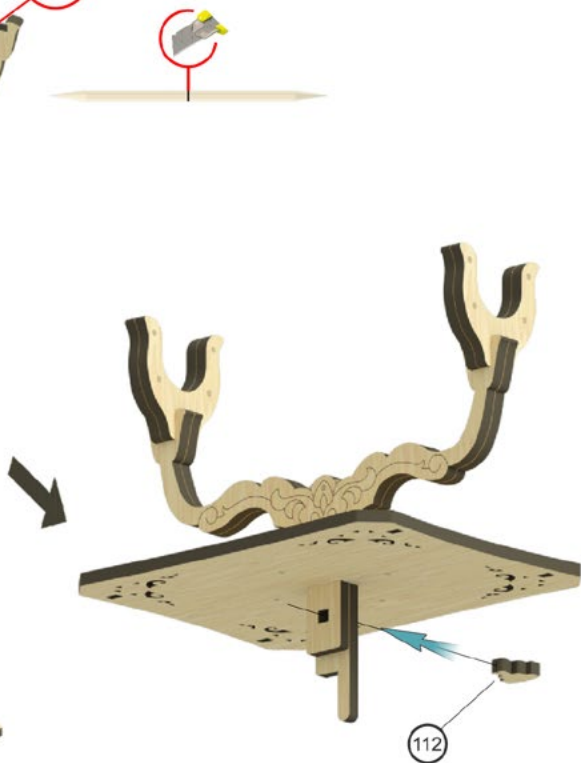
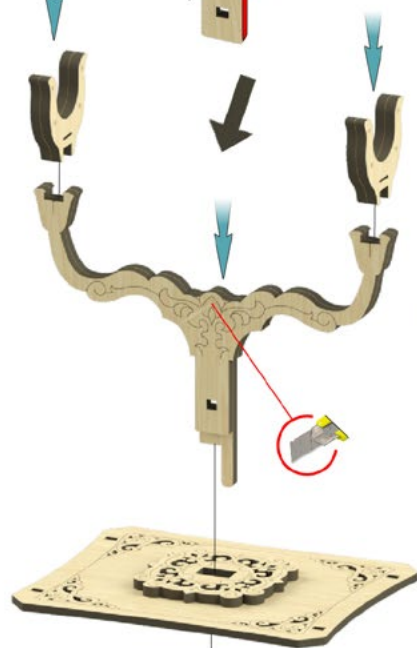

112

59

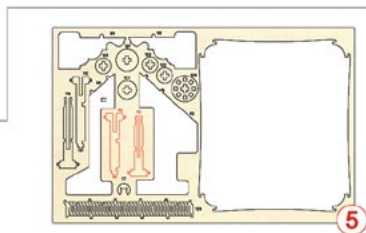
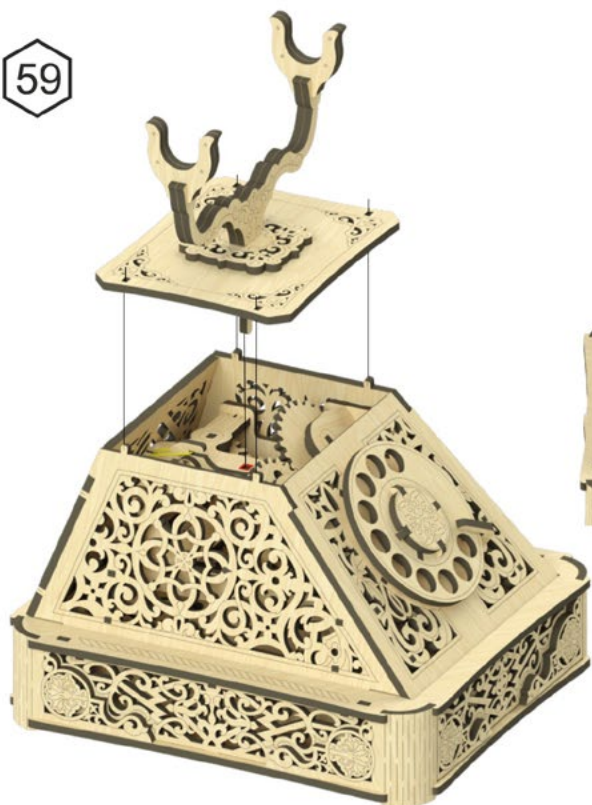

60

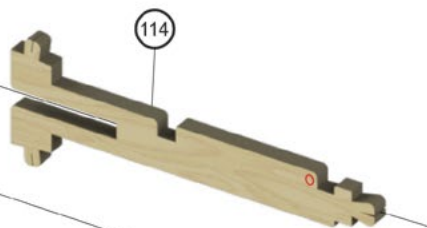
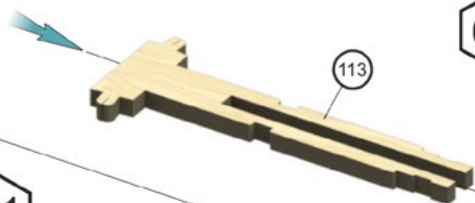

61

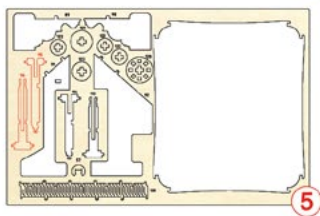
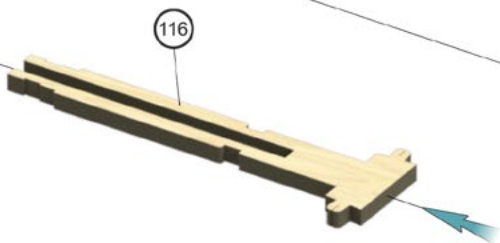
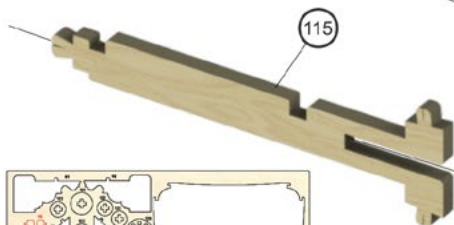

62

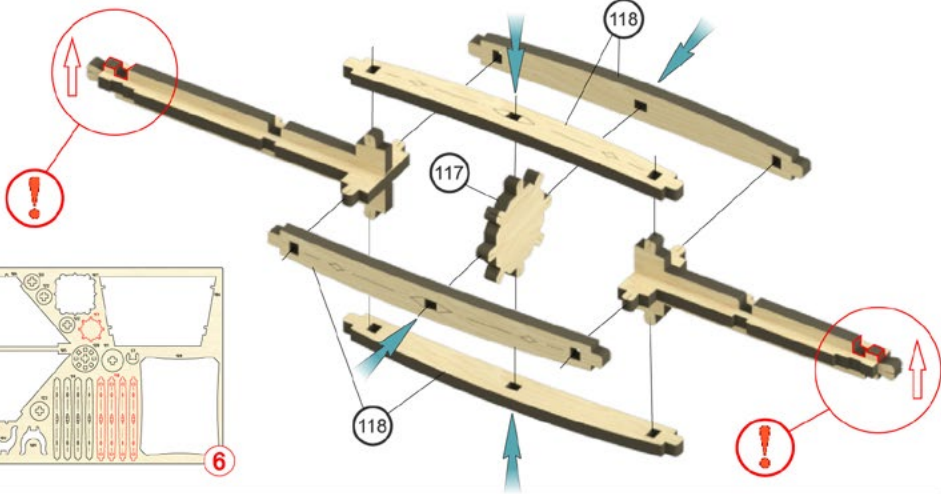

63

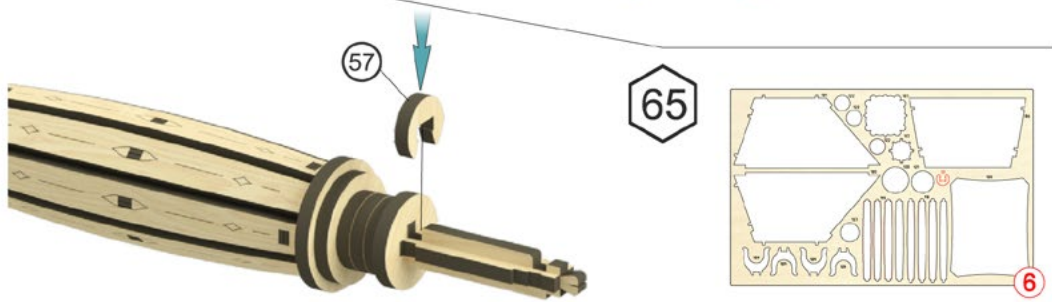
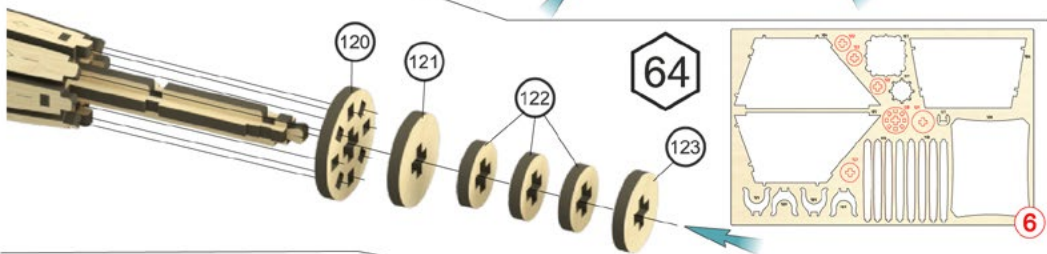
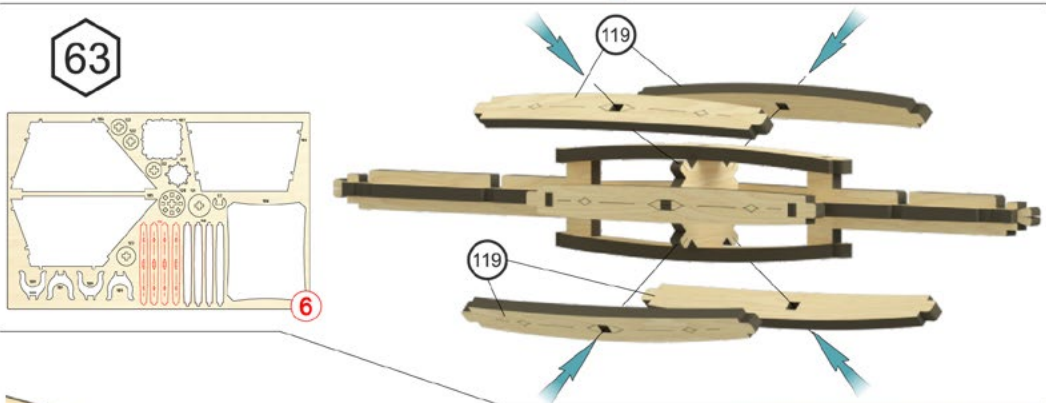

65

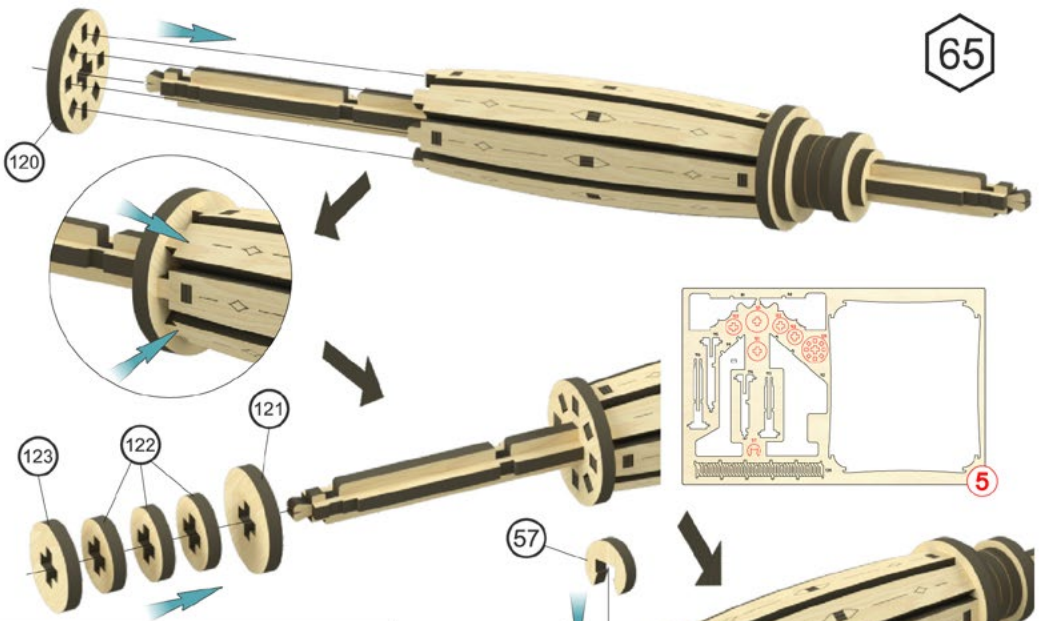

66

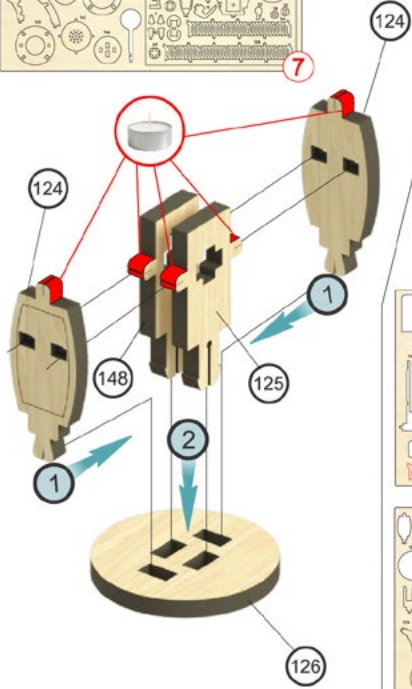
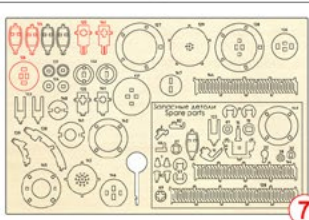

67

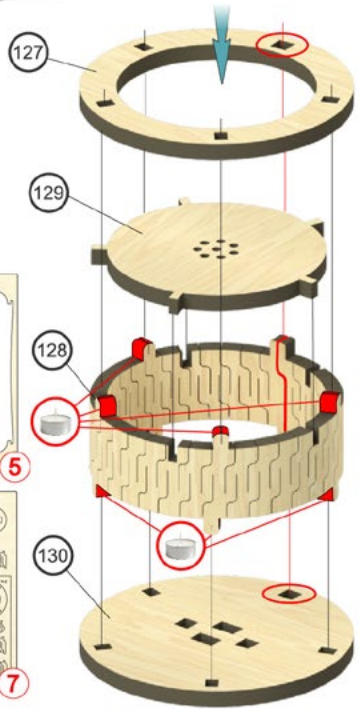
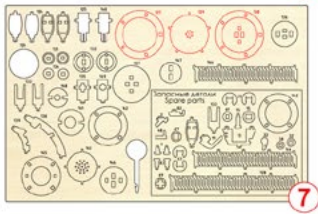
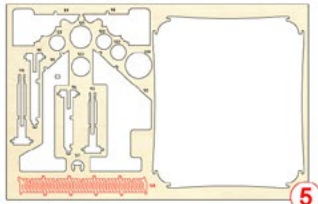

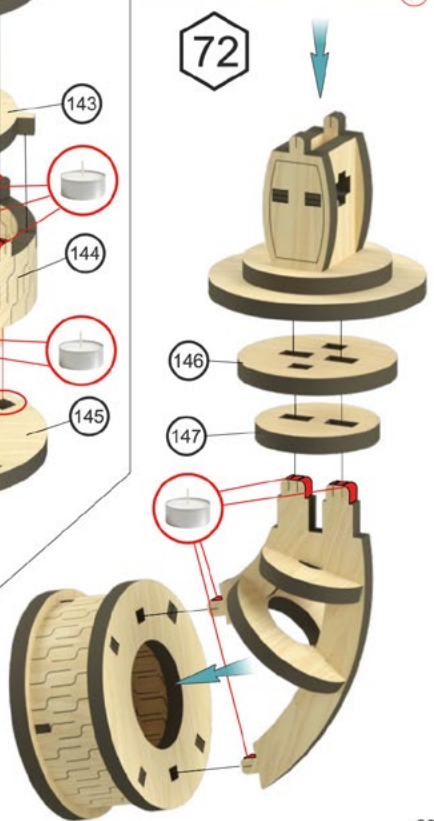
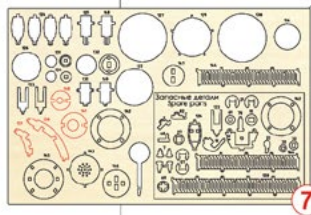
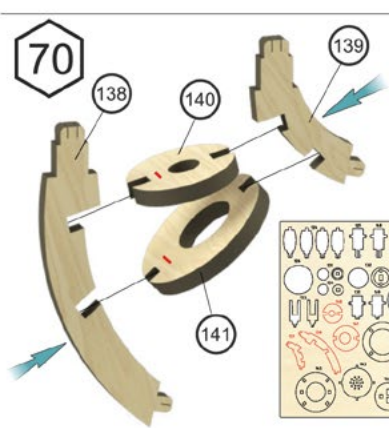
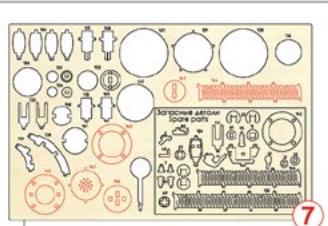
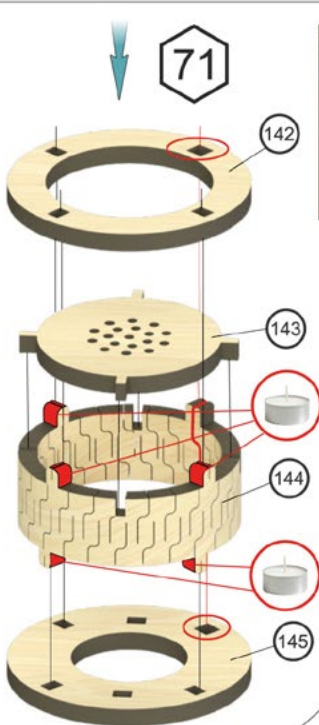
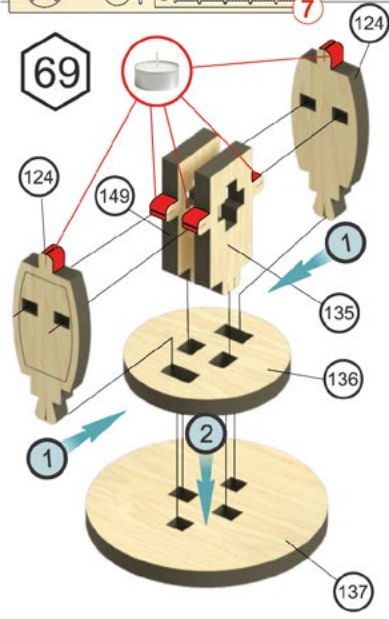
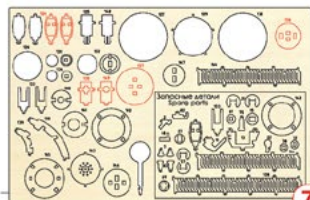
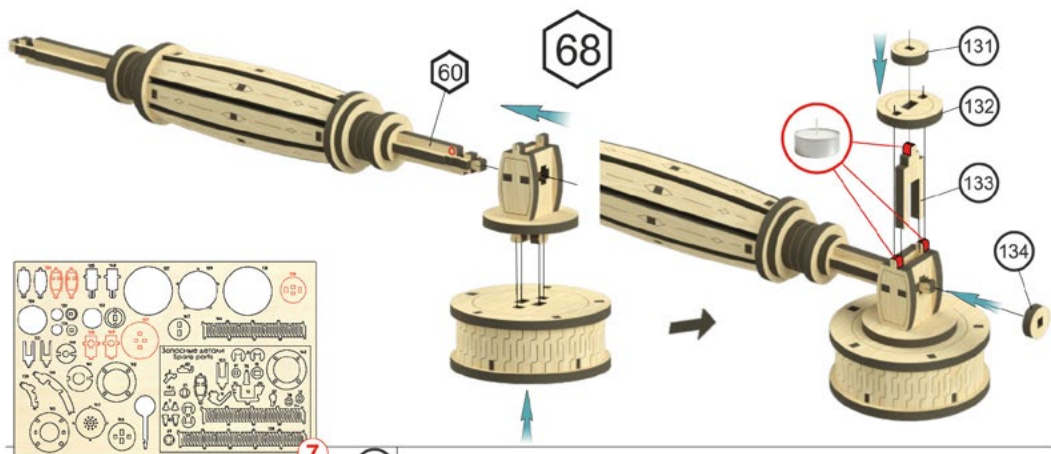

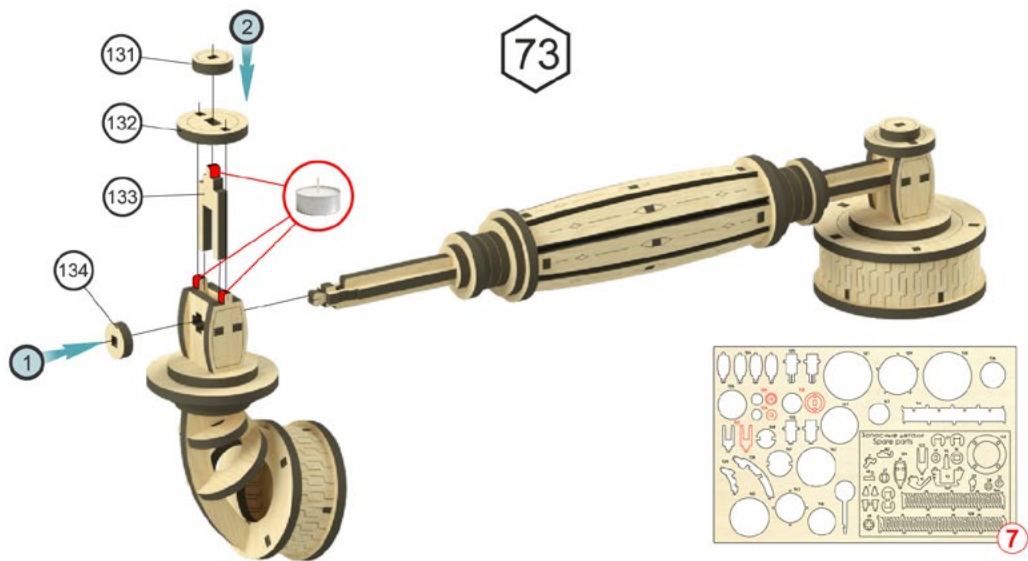

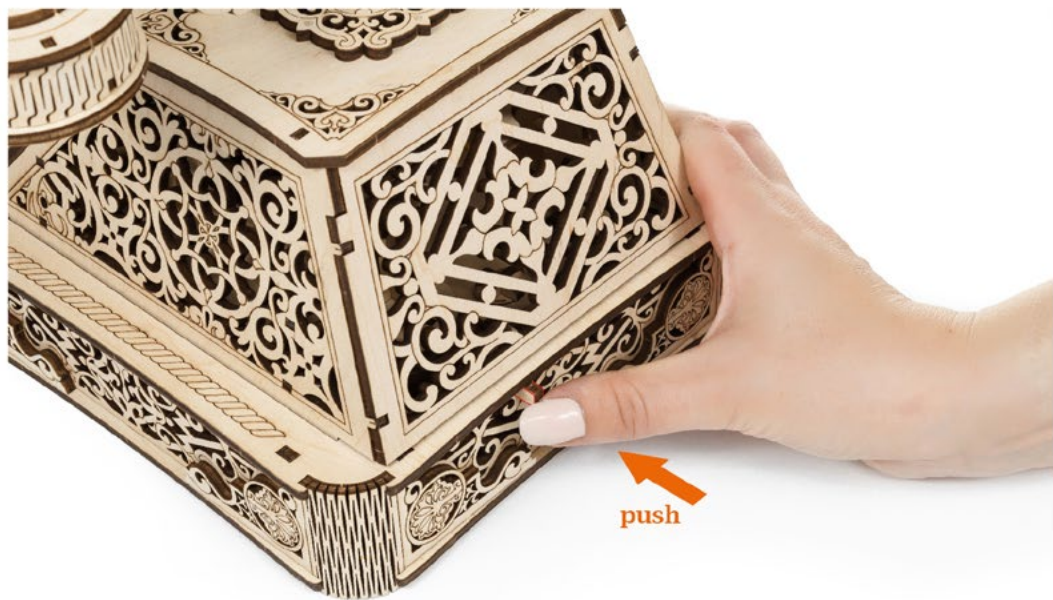

## OTHER WOODEN CONSTRUCTIONS FROM EWA ECO-WOOD-ART



**FIRE TRUCK**



**TRACTOR 'KIROVETS'-K7M**



**TANK T-34/85**



**SKYLORD**



**LUNOKHOD**



**WINDMILL**



**CRUISER**



**GRAMOPHONE**



**PLANETARY GEAR**



**BELAZ 75600**



**TRACTOR BELARUS-82**



**CAT**



**MAZ 6440RR**



**LOCOMOTION #1**



**TRICERATOPS**